



Installation Instructions  
**1965-87 Turbo Hydramatic  
400 Transkit**

Part Number 20229

© B&M Automotive Products 1993

The B&M TransKit you have purchased contains all of the parts necessary to convert your stock transmissions to the same basic specifications found in the famous B&M Transmission. This kit has been assembled with the assumption that all of the stock parts needed will be reusable. However, upon disassembly of a transmission that has excessive mileage or has been abused, you may find that certain stock parts will have to be replaced. New parts may be purchased from your dealer although in many instances you may wish to purchase used parts from a wrecking yard or transmission repair shop.

You will also note that the B&M TransKit includes all the friction discs and bands that are in your transmission.

We suggest that you take the time to completely read through the instructions before beginning disassembly so that you will be properly prepared with all of the necessary tools and materials. (See Tool and Material List.)

Note: Do not install this kit in 1988 or later TH 400's. This kit will only work correctly in 1965 to 1987 TH 400's.

When reading the instructions without the disassembled transmission in front of you, you may be confused. Don't worry, with the transmission actually apart you will find the instructions are simple and easy to follow.

#### Additional B&M Parts

While you have your transmission apart there are a number of other B&M accessories that you may want to consider:

1. Torque Converter. For street applications we recommend either our 11" Holeshoot 2400 or, for those that want a little more performance, the 10" Holeshoot 3000 is an excellent choice. For RV/Heavy Duty applications we recommend our Traveler Converter which has slightly more stall than stock and provides additional horsepower for taking off with heavy loads or trailers. The Traveler also provides for additional downhill braking effect as well. For more converter information consult the B&M catalog.

2. A major problem on TH-400 transmissions has been air leaking around the oil pickup. Our special Competition Oil Pickup Kit (#20287) which includes our Special Filter (#10288) will solve this problem as well as insure longer transmission life through more complete filtering.

Printed in U.S.A.

3. Deep Pan. The special cast aluminum B&M Deep Pan (#20280) not only looks good it adds extra oil capacity for longer life and cooler temperatures, plus it actually makes the transmission case more rigid, an important consideration for competition and off-road vehicles. B&M also offers a stamped steel Special Deep Pan (#20289) that is chrome plated and offers all the features of the cast pan (except extra rigidity) and is less expensive.

4. Special Intermediate Sprag Assembly. B&M offers a heavy duty Intermediate Sprag Assembly (#20279) that we consider a must for all-out competition. Special sprag increases torque capacity by 110% over stock unit.

5. Manual Valve Body. You can obtain full manual upshifts by installing the B&M Manualpak #20219. You may also consider the Four "0" Transbrake for the ultimate launch and manual control #21003. Consult the B&M catalog for full details.

6. Transmission Oil Cooler. We feel that it is very important that every vehicle used in a heavy duty application; racing, towing, RV, etc., should have a supplementary transmission oil cooler. B&M now offers coolers that feature excellent efficiency and high oil flow. Consult B&M catalog for details on Supercoolers.

7. B&M now offers 300M input shafts and steel clutch hubs for the TH-400 transmission. The 300M shaft has a lifetime warranty against shaft breakage from torsional failure. The shaft comes complete with a modified forward clutch drum #21214. The alloy steel clutch hub is substantially stronger than the factory and also contains an oil dam to direct more oil to the clutches #21202. These components are a must for high torque applications and all Off-Road race vehicles.

8. S.F.I. approved transmission shields are available for the TH-400 and are required on all vehicles running 9.99 or quicker #22151. These B&M shields will fit the standard depth pan or with a cast deep pan. Consult the B&M catalog for complete details.

SPECIAL NOTE: If your present transmission has a Shift Improver Kit installed make sure you remove all of those parts before making the modifications outlined in the TransKit.

9500010-08

## INTRODUCTION

The B&M TransKit contains all special parts, friction materials, and gaskets to modify your stock transmission to B&M specifications. Included in the instructions are optional machining modifications B&M performs to their units.

This kit can be installed in a few hours by carefully following directions. Read all instructions first to familiarize yourself with the parts and procedures. Work slowly and do not force any parts. Transmission components and valves are precision fit parts. Burrs and dirt are the number one enemies of an automatic transmission. Cleanliness is very important, so a clean work bench or area is necessary during assembly. Every attempt has been made to simplify assembly and minimize the use of special tools. For additional reference you may wish to obtain a shop manual from the vehicle manufacturer or an aftermarket reference book company.

Since this kit involves a complete overhaul the transmission will have to be removed from the vehicle. Due to the many different models available we cannot cover each vehicle in detail, included, however, are basic removal and replacement instructions.

This kit contains all parts necessary to obtain any of three levels of performance depending on intended use:

1. **Heavy Duty:** Towing, campers, motorhomes, police, taxi, etc. This is a heavy duty modification intended for high capacity without harsh shift feel.
2. **Street:** Dual purpose performance vehicles. Also on/off-road performance. Firm positive shift feel but acceptable for daily street driving.
3. **Track:** Race cars only. Not to be driven on the street. Maximum shift feel. Trailered or towed race vehicles only. Extremely high shift points are unsuitable for street use.

Automatic transmissions operate between 150°F and 250°F. It is suggested that the vehicle be allowed to cool for a few hours to avoid burns from hot oil and parts. The vehicle must be off the ground for ease of transmission removal. Jack stands, wheel ramps, or a hoist will work fine. **Make sure the vehicle is firmly supported!** Try to raise it 1-2 feet so you have plenty of room to work easily. A transmission or floor jack should be used to prevent injury and/or transmission damage during transmission removal. Have a small box or pan handy to put bolts in so they won't get lost. Also have a drain pan handy to catch oil.

## TRANSMISSION REMOVAL

**STEP 1.** Turbo Hydro 400 transmissions do not have drain plugs. You will be installing a drain plug kit in the pan later but for now you will have to drain the oil pan by loosening the bolts and allowing the oil to drain past the pan gasket. Loosen the pan bolts slowly but do not remove them. If the pan sticks to the gasket pry it loose with a screwdriver. After the oil

drains snug the pan back into place.

**STEP 2.** Remove the driveshaft assembly. Be careful not to drop or damage the driveshaft or the smooth bushing/seal diameter of the slip yoke. Now is a good time to clean and inspect your U-joints.

**STEP 3.** Loosen and disconnect oil cooler lines. Try to use a fitting wrench to avoid damaging the compression fitting nuts on stock oil cooler lines. Also disconnect vacuum line to vacuum modulator. (See Fig. 1)

**STEP 4.** Disconnect kickdown cable wire on left side of case. (See Fig. 2) Disconnect shifter linkage. On cable shift models (floor consoles) unbolt cable bracket from pan and leave cable attached to bracket. Disconnect speedometer cable.

**STEP 5.** Remove dust pan at front of transmission to expose torque converter. Turn engine over slowly to expose and remove the three converter bolts. The converter will now rotate freely. If it does not, use a screwdriver to pry it back slightly and free it from the crankshaft.

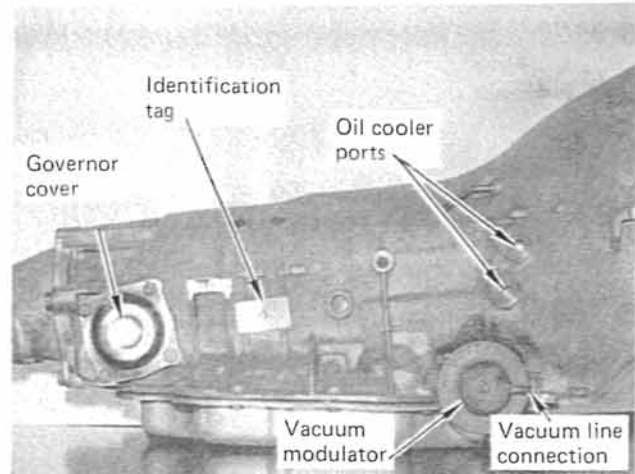

FIGURE 1

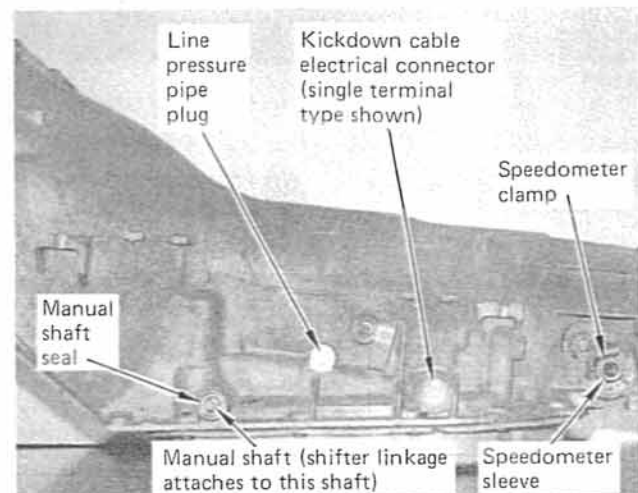

FIGURE 2

**STEP 6.** Place jack under transmission. Unbolt and remove the crossmember assembly. It is advisable at this point to remove the cap and rotor from the distributor to prevent damage.

**STEP 7.** Remove the transmission to engine bolts. Pull the transmission back slightly away from engine. Make sure the converter does not fall out. Lower transmission/converter assembly. It may be necessary to remove dipstick tube now to lower transmission completely. Remove transmission/converter assembly from vehicle. You may wish to consider the installation of a special B&M converter upon re-assembly. Consult the B&M catalog for correct converter for your application.

Once the transmission is completely out of the vehicle the torque converter can be pulled off the front. Some oil will leak out at this time. Drain the torque converter as completely as possible and cover the neck to keep out dirt. There will still be about 1-2 quarts of oil in the transmission. You should plan to disassemble the transmission in an area where this oil can be cleaned up easily.

There have been several different model TH400 transmissions produced since 1965. Where there are differences in disassembly procedures they will be so noted in the instructions. If you find it necessary to replace any transmission hard parts during TransKit installation, make sure to use the information on the I.D. tag on the right side of the case when you go to your G.M. dealer. (See Fig. 1)

Modifications will be done in sub-assembly steps to avoid confusion and parts mix-up. Work slowly and follow the directions. If you do not understand a step, read it again. **Do not guess at anything.** It will also be helpful to make notes on the instructions for model reference.

### DISASSEMBLY Section A

**STEP 1.** Remove oil pan. This will expose the oil filter. There are two types of oil filters.

**'65-'67 models:** You will have a long box-like filter which runs along the left side of the valve body. (See Fig. 3) Remove this filter by pulling it straight off.

**'68-'87 models:** You will have a large flat ripple surface filter held in place by a center bolt. (See Fig. 4) Remove the center bolt first and then pull the filter off. There is a short tube (plastic or steel) which connects the filter to the case hole. If it did not come out with the filter remove it now.

Remove and discard the pick-up tube O-ring from the case hole if it did not come out with the filter tube. When you purchase a new oil filter, make sure you get the correct model as there is a difference in oil pans. We highly recommend you install B&M's Competition Oil Pickup Kit #20287. This kit positively prevents air leaks and provides improved filtration over stock units.

**STEP 2.** Observe the location of the following: (See Fig. 5) Manual linkage (shifter) detent spring and roller, engagement

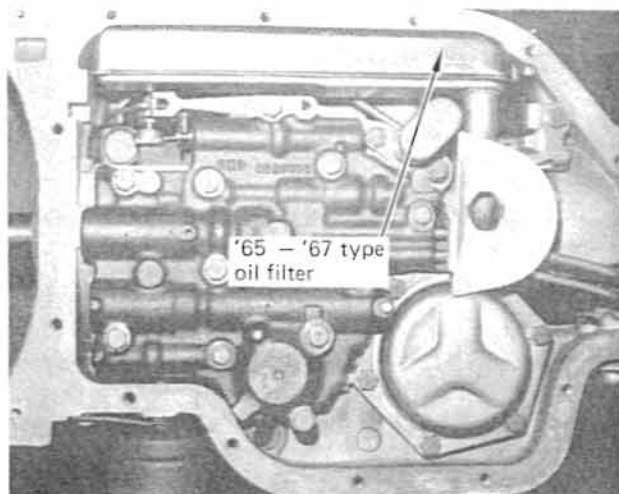

FIGURE 3

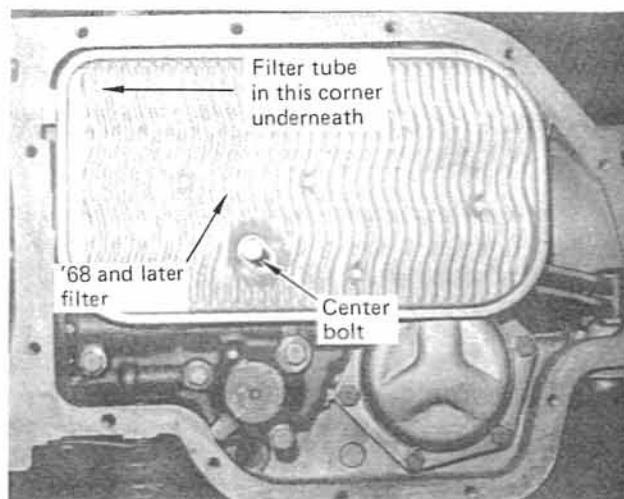

FIGURE 4

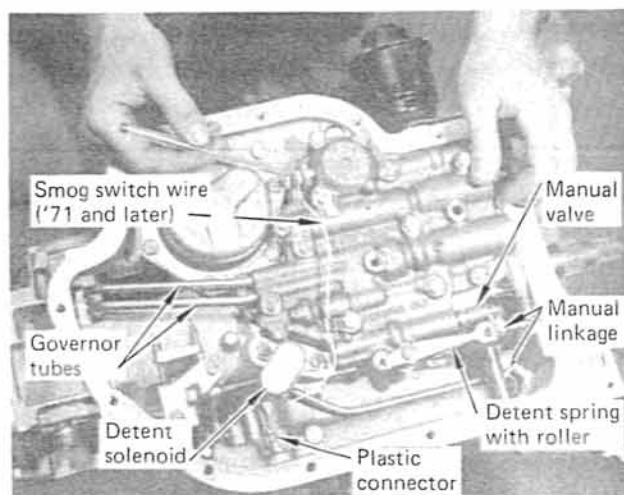

FIGURE 5

of the manual valve into the linkage, governor tubes, detent solenoid (oval or square can) and plastic connector. There are three different connector combinations:

**Type 1:** One-terminal type which goes to the detent solenoid.

**Type 2:** '65-'67 variable pitch (Buick - Olds - Cadillac only, some models). Two-terminal type with both wires in a common plastic plug. One wire goes to the detent solenoid and one wire follows the valve body up to the front of the transmission.

**Type 3:** '71 and later smog two-terminal type. One wire goes to the detent solenoid and the other separate white wire goes to a pressure switch on the valve body. (See Fig. 5)

### STEP 3. Disconnect wires from connector.

**Type 1:** Unplug single wire and allow to hang free.

**Type 2:** Hold lock tab out of the way and unplug plastic plug from connector. Use a small screwdriver to disengage metal terminal from plug connected to long wire to front of transmission. Also unhook long wire from clips on valve body bolts and allow to hang free.

**Type 3:** Unplug detent solenoid wire. Unplug white smog switch wire from connector and pressure switch. Unhook white wire from valve body bolt clip and remove.

**STEP 4.** Remove valve body bolts. Three bolts are 1/4-20, the rest are 5/16-18. Keep drain pan underneath the valve body as there is an additional pint of fluid between valve body and case. Hold the valve body in place as you remove the last bolt. Remove the valve body and governor tubes together. (See Fig. 6) If your transmission has a lot of miles on it, the gaskets may be stuck. Free the valve body by carefully prying up with a screwdriver. Do not use excessive force. Hold on to the manual valve during removal so it does not fall out and get damaged. Set the valve body, valve body bolts and governor tubes aside. Discard any filters in the governor tube holes.

**STEP 5.** Remove two bolts which hold the detent solenoid in place. Set the detent solenoid with the valve body. Discard the solenoid gasket. NOTE: Square can solenoids do not have a gasket. Remove and discard both valve body gaskets and separator plate. Remove six 1/4" steel balls from the case and set them with the valve body. (See Fig. 7)

**STEP 6.** Remove front servo assembly by grasping front servo piston pin and pulling entire assembly from case. (See Fig. 7) You will remove: Pin, piston, washer or C-clip, spring retainer and spring. (See Fig. 52 & 53) Put these parts in the oil pan so they won't be lost. Remove and discard piston seal ring if it is metal. Do not remove teflon seal ring.

**STEP 7.** Remove six rear servo cover bolts. (See Fig. 7) Remove servo cover. Remove servo by pulling straight out. If the servo sticks tap on the side with a screwdriver handle

until it comes free. There is an amount of oil under this servo so don't jerk it out and make a mess. Remove rear servo piston, 1-2 accumulator piston and accumulator spring. (See Fig. 50) Remove and discard aluminum servo cover gasket, servo piston seal, and remove and discard accumulator seal rings if they are metal. Do not remove teflon seal rings from the accumulator pistons.

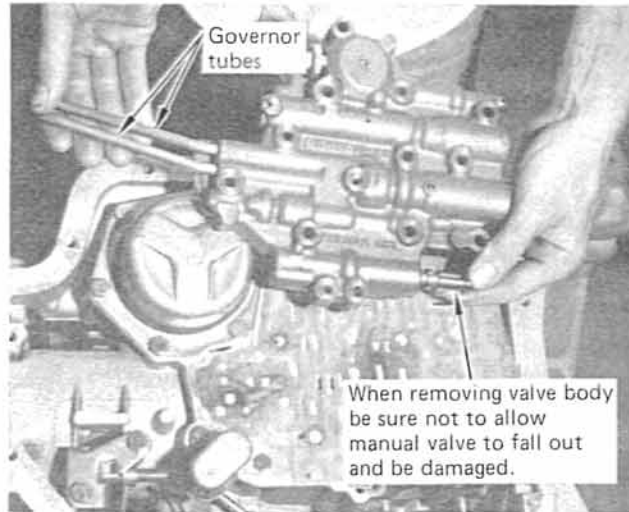

FIGURE 6

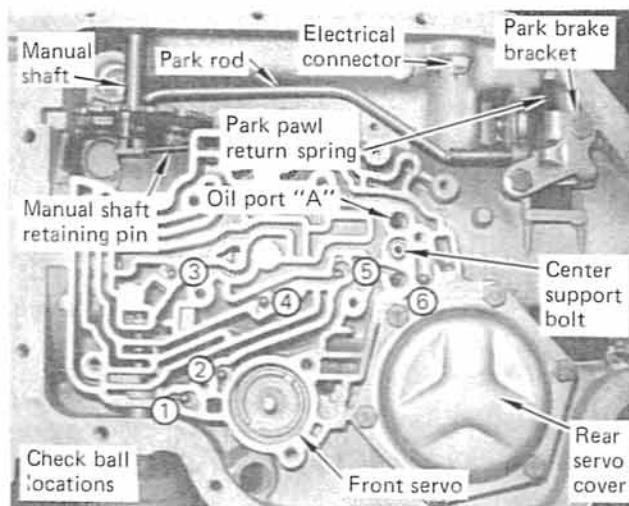

FIGURE 7

**STEP 8.** Remove vacuum modulator retaining bolt and clamp. (See Fig. 8) Remove vacuum modulator and O-ring. Discard O-ring. Reach into modulator bore in transmission case with a pair of needle nose pliers and carefully remove modulator valve. Set them in the oil pan.

**STEP 9.** Remove speedometer retaining bolt and clamp. (See Fig. 2) Pull speedometer sleeve and driven gear out of transmission. Remove and discard O-ring and inner seal. Do not lose small wire clip for inner seal. Put sleeve and gear in oil pan.

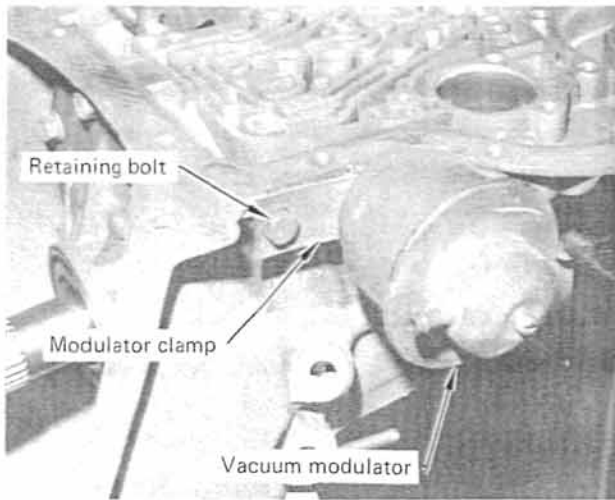

FIGURE 8

**STEP 10.** Remove governor cover bolts and cover. (See Fig. 1) Remove and discard gasket. Remove governor by pulling straight out. Governor will rotate slightly during removal. Put governor in oil pan.

**STEP 11.** Remove center support bolt. (See Fig. 7) Use a 3/8" 12-point socket. Put bolt in oil pan. Also remove electrical connector. Remove and discard O-ring. Put connector in oil pan.

**STEP 12.** Remove eight oil pump retaining bolts. (See Fig. 9) Note: Some '73 and later units only have six bolts. The two bolt holes at the 5 and 10 o'clock positions are tapped for 3/8-16 thread. Install slide hammers or a length of chain at these locations and "bump" the pump assembly out of the case. On variable pitch models be careful not to damage the wire connected to the solenoid. Remove and discard pump gasket except on variable pitch models where it is attached to the pump. Remove and discard pump O-ring around the outside of the pump housing. Set the oil pump assembly aside.

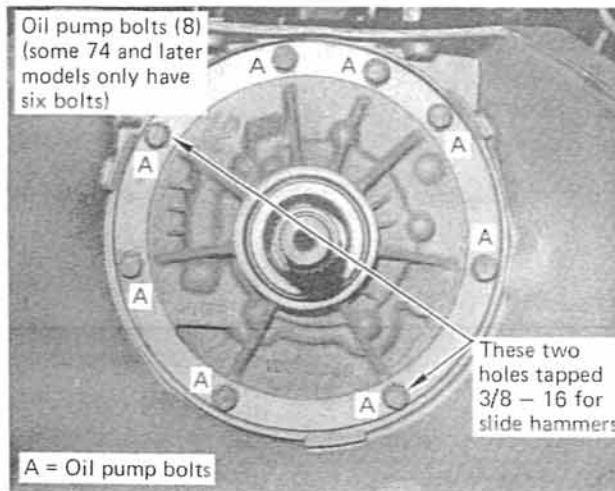

FIGURE 9

**STEP 13.** Grasp input shaft and remove input shaft/forward drum assembly. (See Fig. 10) Make sure you don't lose the thrust washer on the splined hub on the back of the drum assembly as it may stick to the direct clutch drum still in the case. Set the forward drum assembly aside.

**STEP 14.** Remove the direct clutch drum assembly. (See Fig. 11) It will pull straight out. The sun shaft may come out at this time. This is OK. Set the direct clutch drum aside. Remove the front band by disengaging it from the anchor pin and pulling it out. (See Fig. 12) Set the band aside.

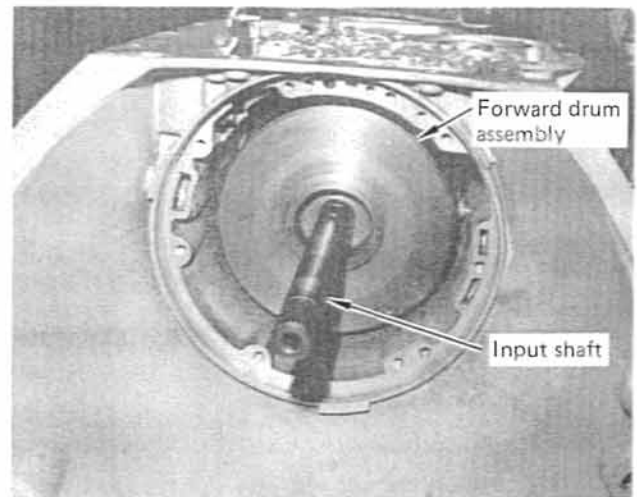

FIGURE 10

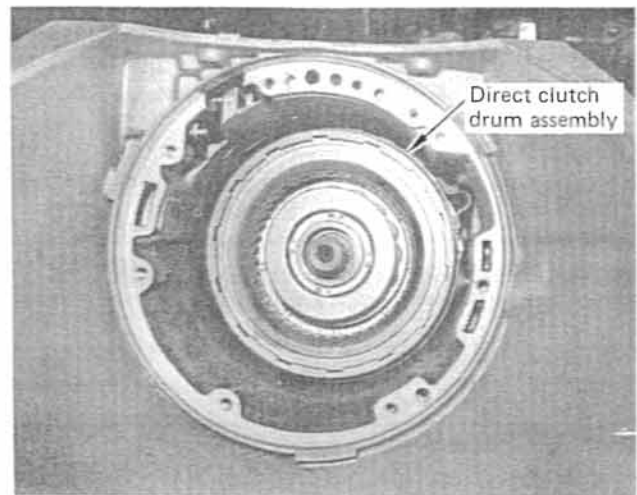

FIGURE 11

**STEP 15.** Remove the intermediate clutch snap ring. (See Fig. 12) Remove intermediate clutch backing plate and set it aside. Remove and discard three intermediate clutch plates and three steel plates.

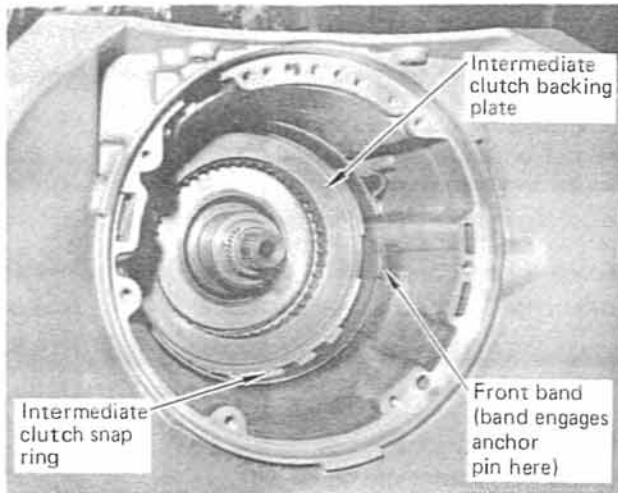

FIGURE 12

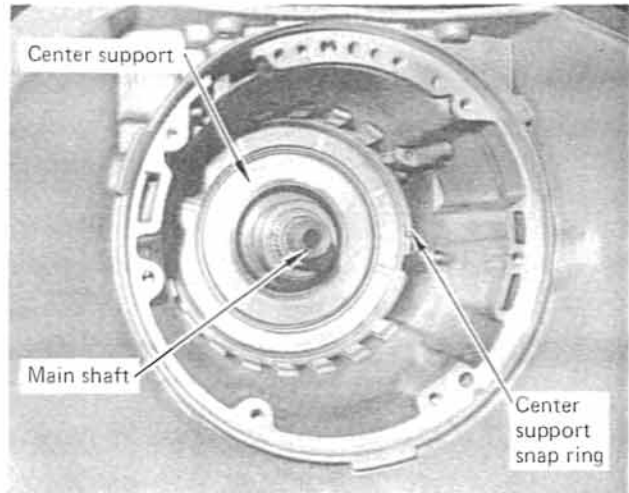

FIGURE 13

**STEP 16.** Remove the center support to case snap ring. (See Fig. 13) Grasp the center support and pull it out. When you remove the center support, check the back side for a bearing race and inside the recess for a plastic or bronze thrust washer. (See Fig. 14) Grasp the main shaft and remove the entire planetary geartrain assembly. Set them aside.

**STEP 17.** Remove the output shaft to case thrust washer and selective thrust plate. (See Fig. 14) Note: They may be stuck to the back of the output shaft. Some models have a center support spacer. This is a thin snap ring located just behind the center support in the case. If your transmission has one, remove it. Remove rear brake band.

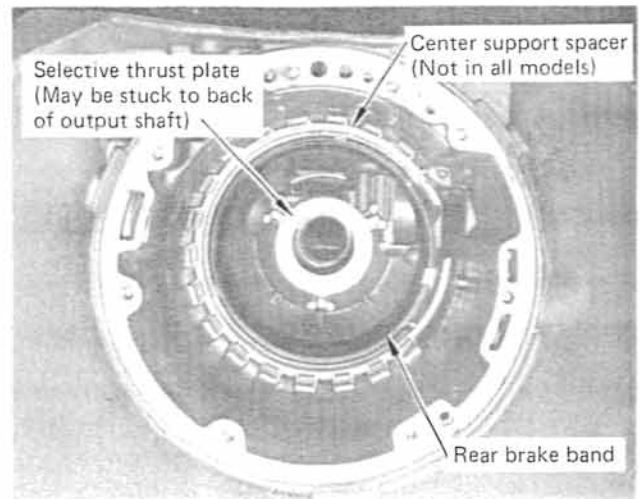

FIGURE 14

**STEP 18.** Remove park brake bracket bolts and bracket. (See Fig. 7) Remove the park pawl return spring and bracket. Remove park rod. Remove manual shaft retaining pin (nail). Loosen inside detent lever nut and slide manual shaft out of case. Note: Be sure to file off any burrs that may be on the manual shaft before trying to remove it. If you scratch the bore it will leak. (See Fig. 15) The shaft should slide out freely. If the manual shaft has O-rings on it, discard them. Put linkage parts in the oil pan.

**STEP 19.** Remove six extension housing bolts and remove extension housing. Discard gasket or O-ring. Remove and discard extension housing seal. Note: 4-wheel drive housing seals will have to be purchased separately as they are not included in kit.

**STEP 20.** Remove cooler fittings from case. Remove 1/8" NPT pipe plug from left side of case at line pressure tap. (See Fig. 2) The case is now stripped and can be cleaned. The park pawl does not have to be removed. When handling the case, be careful not to damage the valve body surface as this can cause erratic operation.

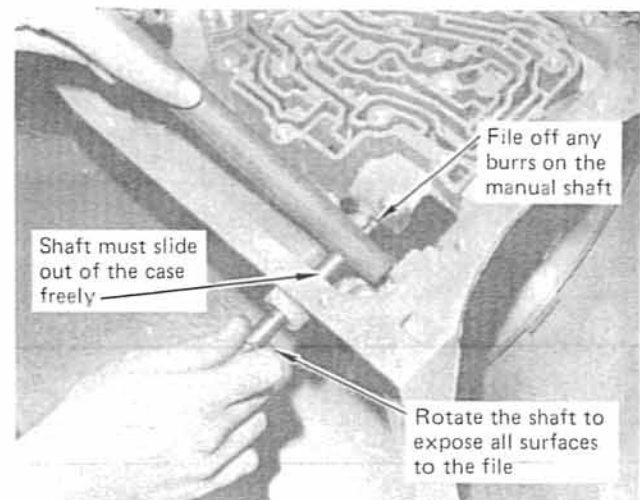

FIGURE 15

## DISASSEMBLY OF SUB-UNITS

### Section B

#### I. Oil Pump

**STEP 1.** Remove stator control solenoid on variable pitch models. (See Fig. 16) Remove and discard gasket.

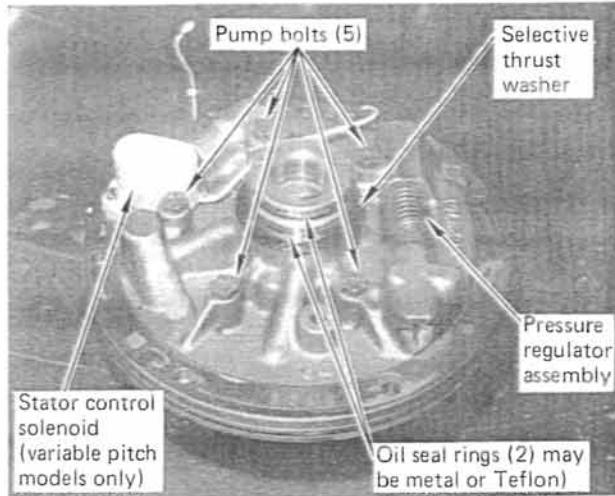

FIGURE 16

**STEP 2.** Remove five oil pump bolts. (See Fig. 16) This will separate the pump body (front half) from the pump cover (rear half). Be careful when handling the pump not to damage pump surfaces or seal ring grooves.

**STEP 3.** Remove rotors (gears) from the body. (See Fig. 17) Remove the front seal being careful not to damage the bushing. Use a screwdriver or chisel to knock the seal out from the inside.

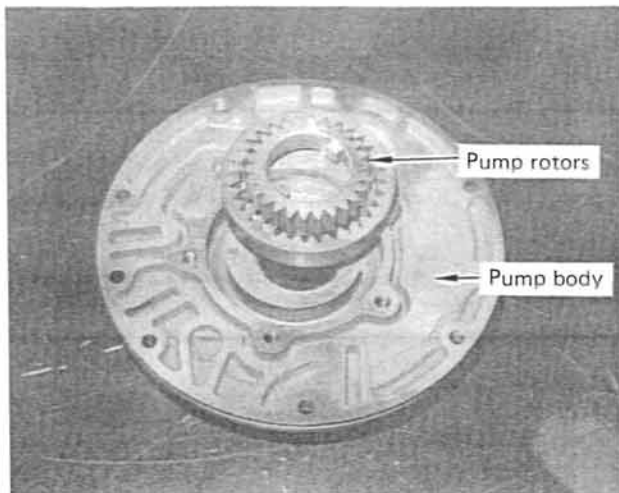

FIGURE 17

**STEP 4.** Remove and discard two metal hook-type or removable teflon seal rings from the back of the cover. (See Fig. 16) Remove the selective plastic thrust washer. Use a pair of snap ring pliers to remove the pressure boost snap ring. (See Fig. 18) Remove pressure boost sleeve and valve, pressure regulator spring and spring retainer, one or two horseshoe-shaped shims, and regulator valve. (See Fig. 19) Hold your hand over the boost sleeve during snap ring removal to prevent parts from flying out and getting lost. Remove the pressure regulator plug and pin from the opposite end of the regulator bore. Keep all the pump parts together. The pump is now

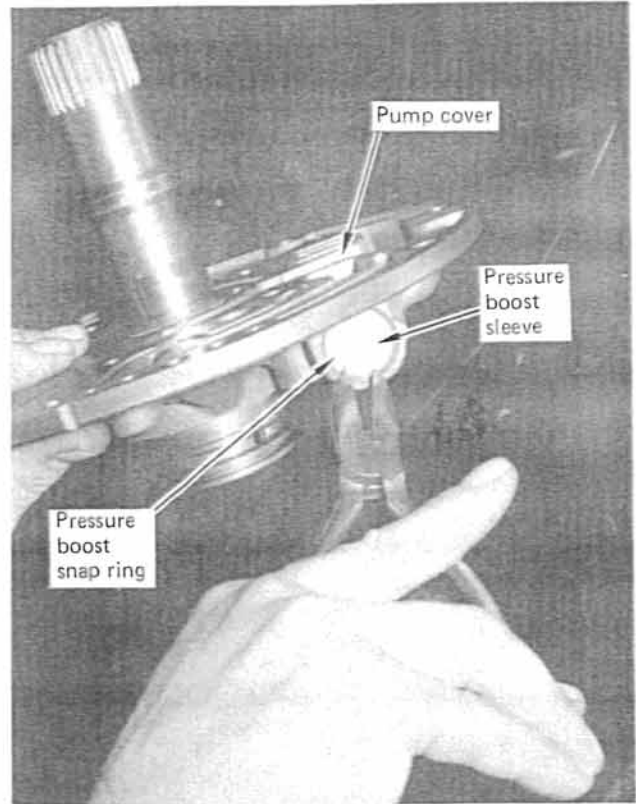

FIGURE 18

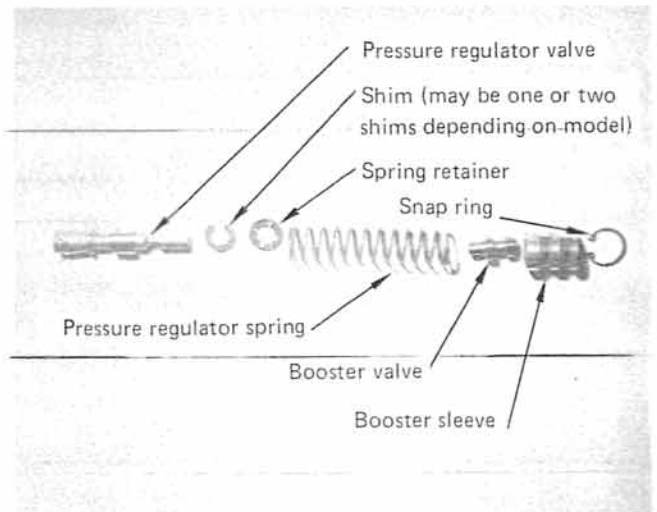

FIGURE 19

ready for cleaning. It will not be necessary to remove the stator signal valve on variable pitch models for cleaning.

## II. Forward Clutch Assembly

**STEP 1.** Remove the snap ring from the rear of the forward clutch housing. (See Fig. 20) Remove the direct clutch driving hub, forward clutch hub, thrust washer and five clutch plates and steel plates.

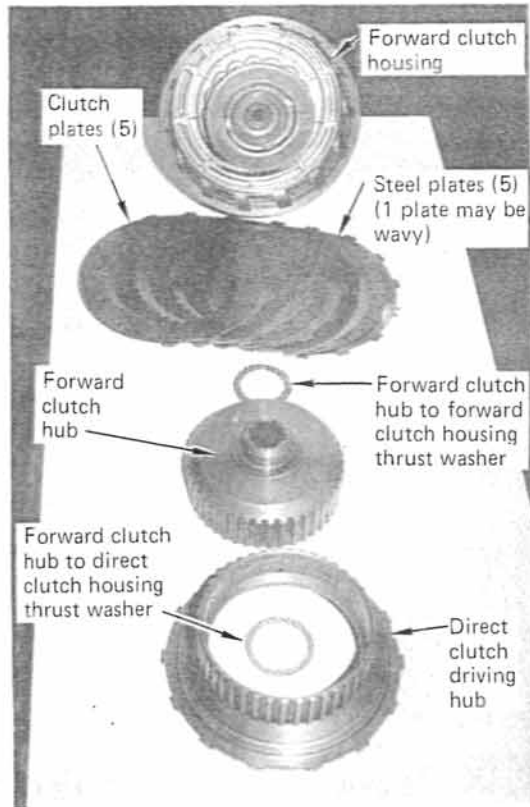

FIGURE 20

**STEP 2.** Place the housing in a press or use two C-clamps to compress the piston return springs and retainer. (See Fig. 21) Remove the retainer snap ring and relax tension on the retainer slowly. Remove retainer, sixteen return springs and forward clutch piston. Note the color code of the springs. Remove and discard two rubber lip seals from the piston and one rubber lip seal from the housing. The forward clutch assembly is ready to clean.

## III. Direct Clutch Assembly

**STEP 1.** Remove the snap ring from the front of the direct clutch housing. (See Fig. 22) Remove the direct clutch backing plate, five clutch plates and steel plates. (Note: Some high performance Chevrolet units may have six plates and steels.) Discard the clutch plates and steel plates.

**STEP 2.** Place the housing in a press or use two C-clamps to compress the piston return springs and retainer. Remove the retainer snap ring and relax tension on the retainer slowly. Remove the retainers, sixteen return springs and direct clutch

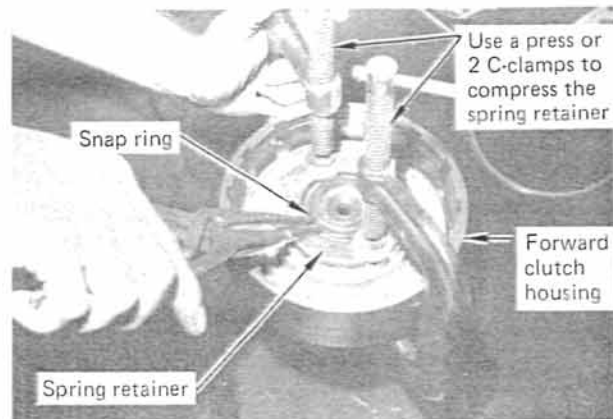

FIGURE 21

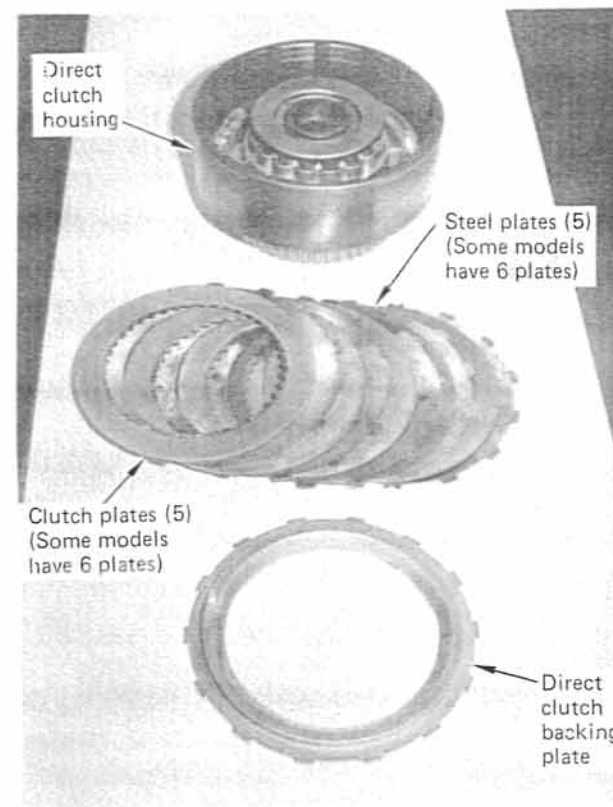

FIGURE 22

piston. Note the color code of the springs. Remove and discard two rubber lip seals from the piston and one rubber lip seal from the housing.

**STEP 3:** Turn the housing over and remove the intermediate overrunning clutch retainer and the intermediate overrunning clutch. (See Fig. 23) There are two types: The more common dog element sprag with end bushings or the late model eight element roller clutch. (See Fig. 24) The rollers may be removed from the cage for cleaning so they don't get lost. Do not remove elements from the dog-type clutch. The direct clutch assembly is now ready to clean.



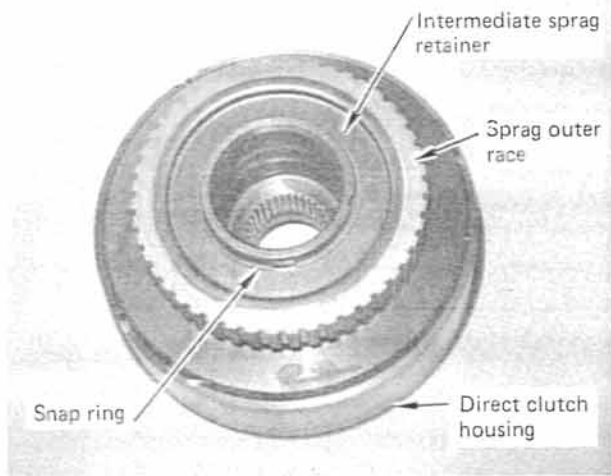

FIGURE 23

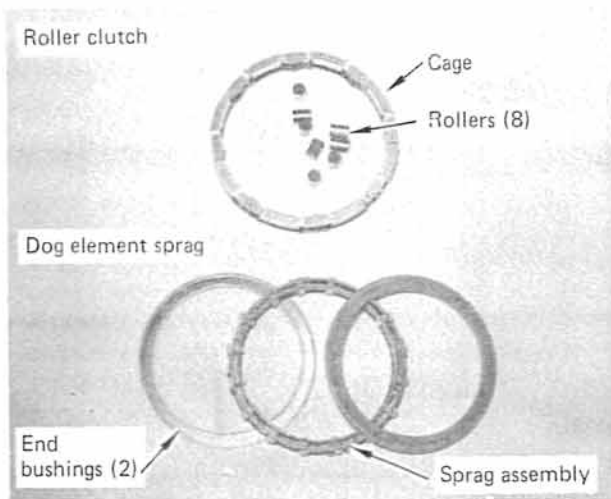

FIGURE 24

#### IV. Planetary Geartrain

**STEP 1.** Slide reaction carrier off the planetary assembly. A bearing assembly will come off at the same time. (See Fig. 25) There will be a plastic or metal thrust washer between the two carriers. There will be a plastic bushing on the outside of the rear carrier. Remove the low reaction overrunning clutch from the carrier. There are two types: '64 - '65 model 36-element sprag assembly and the '66 and later model 16-element roller clutch assembly. Roller elements can be removed from the cage for cleaning. Do not remove elements from the dog-type clutch. Put the overrunning clutch parts in the oil pan.

**STEP 2.** Remove the sun shaft and sun gear. (See Fig. 26)

**STEP 3.** Remove the snap ring from the back side of the output carrier. (See Fig. 27) Note: This is a strong snap ring. Disassemble output shaft from carrier. There is a bearing assembly between the output shaft and the rear internal ring

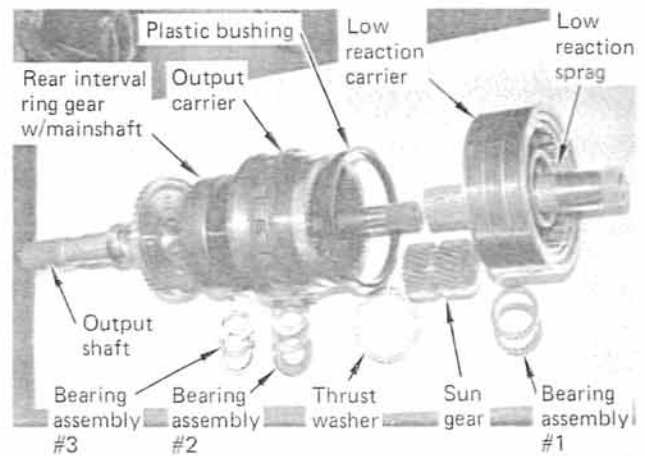

FIGURE 25

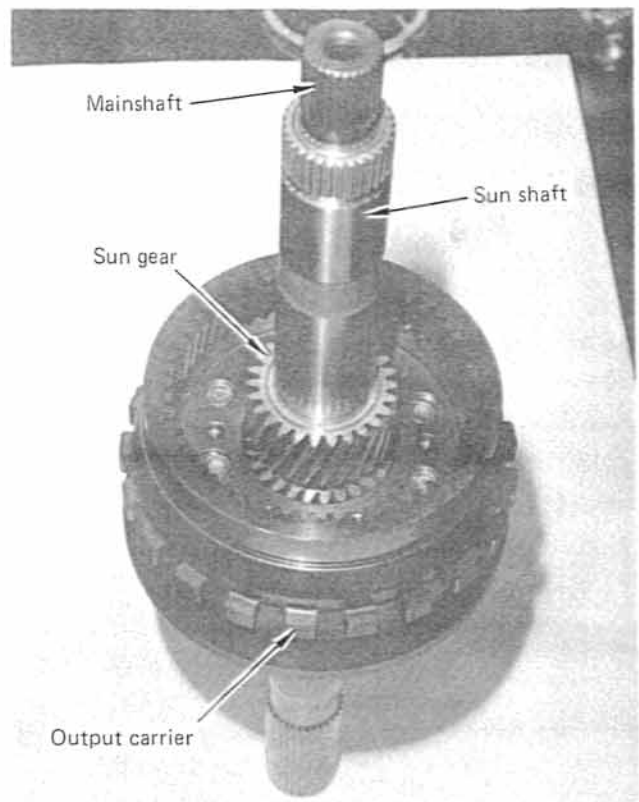

FIGURE 26

gear. Remove the rear internal ring gear from the output carrier. (See Fig. 20) There is another bearing assembly on the front of the rear internal gear. It is not necessary to take the rear internal gear off the main shaft. Put the bearing assemblies in the oil pan.

**STEP 4.** Remove and discard four metal hook-type or teflon seal rings from the front of the center support. (See Fig. 29) Remove the spring retainer snap ring. Remove retainer and three to twelve return springs. Remove and discard two rubber lip seals. Put springs, retainer and snap ring in oil pan.

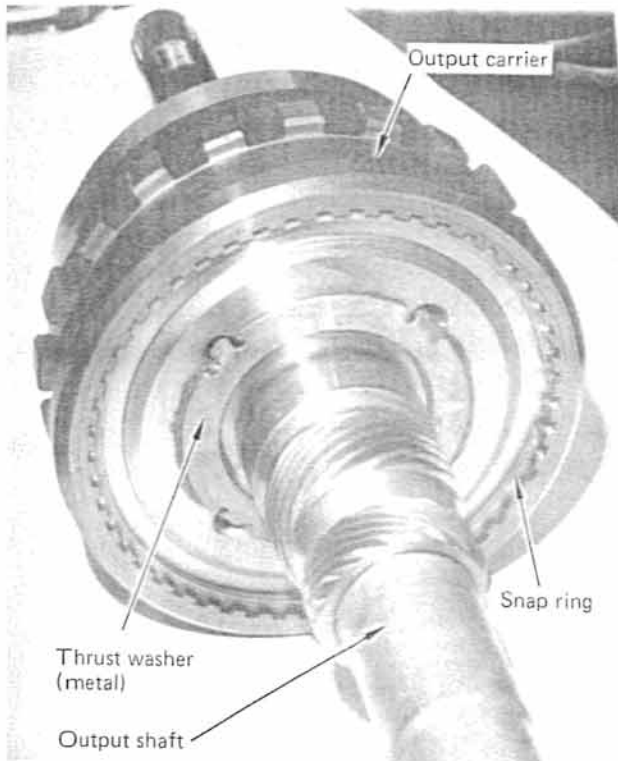

FIGURE 27

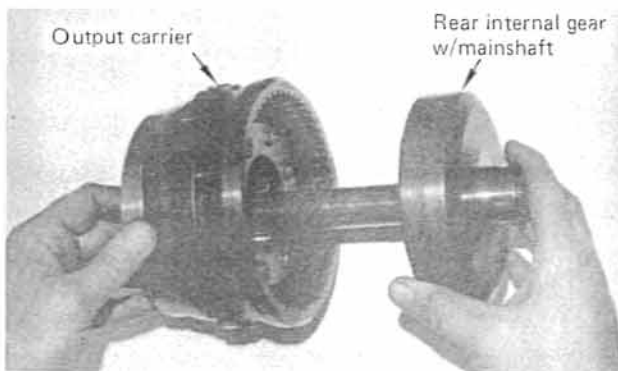

FIGURE 28

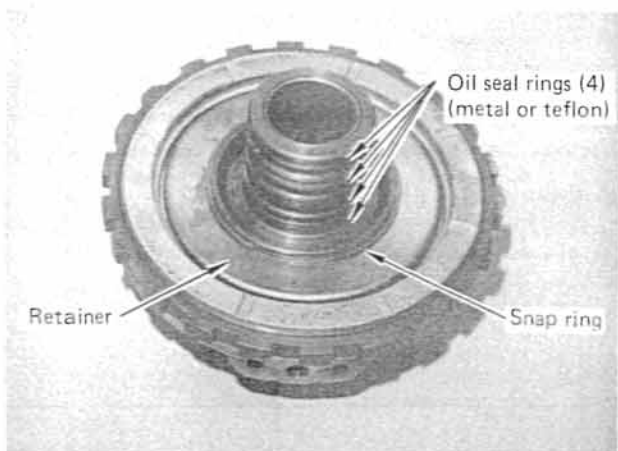

FIGURE 29

## CLEANING

At this point it is time to clean the parts. You will clean the valve body during modification. If your transmission has no amount of visible hard residue or varnish, you can clean the parts satisfactorily in cleaning solvent. For varnished or excessively crusted parts, use a cold degreaser such as carburetor cleaner or "Gunk." To prevent rusting, dip parts in solvent after washing carburetor cleaner off with water. Clean the following parts in solvent only: Vacuum modulator, governor, speedometer gear, plastic connector, springs with a color coding, plastic thrust washers and plastic carrier bushing. Also clean any friction materials or bands in solvent only. Exercise care when handling parts not to nick or damage mating surfaces, ring grooves or machined areas. Do not wipe off internal parts with linty rags!

## SUB-ASSEMBLY AND MODIFICATIONS

### Section C

Note: There are several machining operations B&M does to the transmission to improve performance and life. Some of these operations require tools and/or machines not readily accessible to everyone. Any operations that are not absolutely necessary will be marked "optional" and can be performed if you so desire to get the most out of your transmission.

When performing modification and assembly steps it is important that you do not mix modifications from one level of performance to another (i.e., Heavy Duty in one step, and Street in another step). Also remember the "Track" modifications are not intended to be driven on the street. Shift point calibration is altered and shift points may be unacceptable for street use.

We suggest you have an oil can full of transmission fluid and a supply of grease (Vaseline, white grease, etc.) handy for pre-lubing during assembly.

### I. Valve Body

**STEP 1.** Place the valve body on the bench with the channel side up. Remove the roll pin holding the 1-2 shift modulator valve sleeve in place. (See Fig. 30) Remove the sleeve carefully. This may require a little prying with a small screwdriver. Try not to raise any burrs during removal. Also remove the 1-2 shift valve at the bottom of the bore.

Compare your stock 1-2 Shift valve with the one supplied in the kit. If your valve is the same diameter as the valve supplied, use the B&M valve. If your valve is smaller in diameter, you will need to modify the stock valve.

**Modification to stock valve.** Grind two 1/2" wide flats onto the land nearest the 1-2 spring. (See fig. 30A)

Install the 1-2 shift valve into the bore with the smallest diameter pointing out. (See fig. 30) Reinstall the 1-2 shift

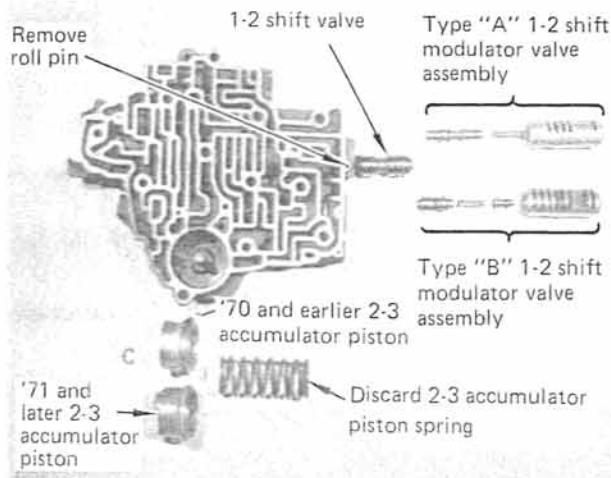

FIGURE 30

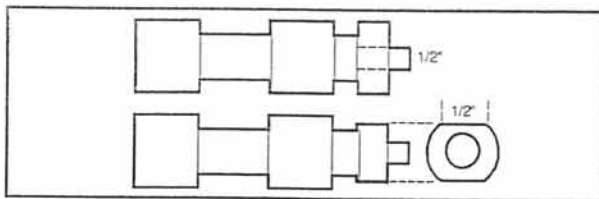

FIGURE 30A

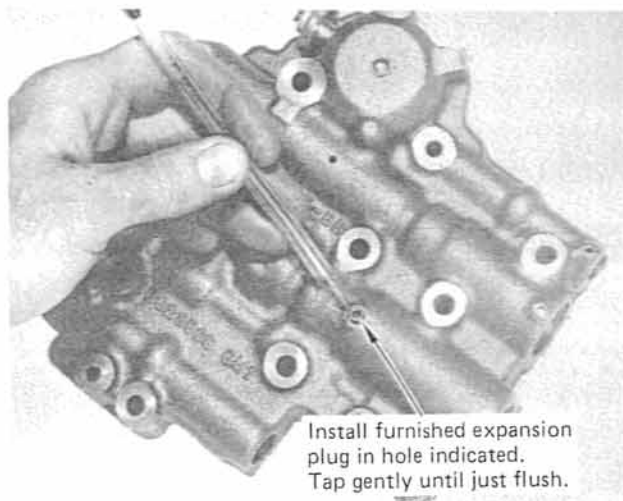

FIGURE 31

modulator valve assembly as removed and replace the roll pin. Using a small, flat screwdriver, check to make sure the 1-2 shift valve slides back and forth freely.

Turn the valve body over and install the special small cup plug in the hole shown in Fig. 31 and tap it down until it is flush with the surface of the valve body. Do not use excessive force. This may distort the casting.

**STEP 2.** Very carefully clamp the valve body in a vise with smooth jaws and compress the accumulator enough to remove the E-clip with a screwdriver. (See Fig. 32) Open the vise slowly and remove the valve body. Remove and discard the accumulator spring underneath the piston. Install the piston as removed. (See Fig. 30) Install the E-clip.



FIGURE 32

Thoroughly clean the casting in solvent or gasoline to remove all dirt. Also scrape off any gasket material that may have stuck to the casting. This is very important. Set the valve body aside where it won't get dirty.

## II. Oil Pump

**STEP 1.** Inspect oil pump body for damage. The area where the pump rotors ride should have no excessive wear. (See Fig. 33) Some scratch marks are normal. The rotor face of the pump cover should have no step at any point where the rotors ride. (See Fig. 34) The rotors themselves should have clean faces and the outer edge of the large rotor should show no metal transfer or wear. (See Fig. 35)

**STEP 2.** Use a large flat fine-tooth file to remove any high spots on the face of the body and cover. (See Fig. 33) Clean the pump halves in solvent to remove any metal particles. Lay the mating surface of the pump body on the upright cover and run a 0.003 inch feeler gage around the edge. (See Fig. 36) The gage should not find any large gaps greater than 0.003 inch. If the mating surfaces vary excessively check for burrs, nicks or high spots which may be causing the problem. Excessive warpage indicates the pump will have to be replaced.

**STEP 3.** Inspect the following areas:

**Pump Bushing:** Replace as necessary.

**Seal Ring Grooves:** Install a sealing ring on each ring groove and make sure it spins freely. Remove any interference with a small flat file.

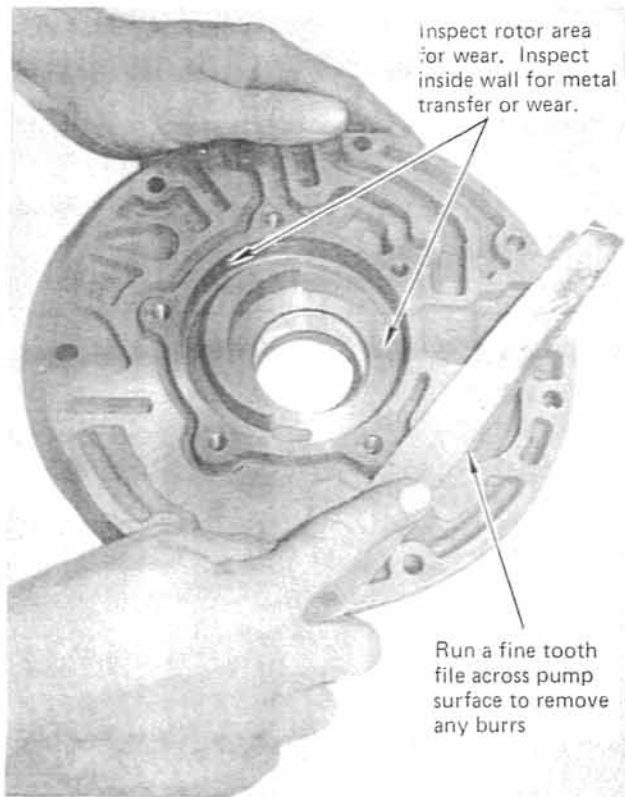

FIGURE 33

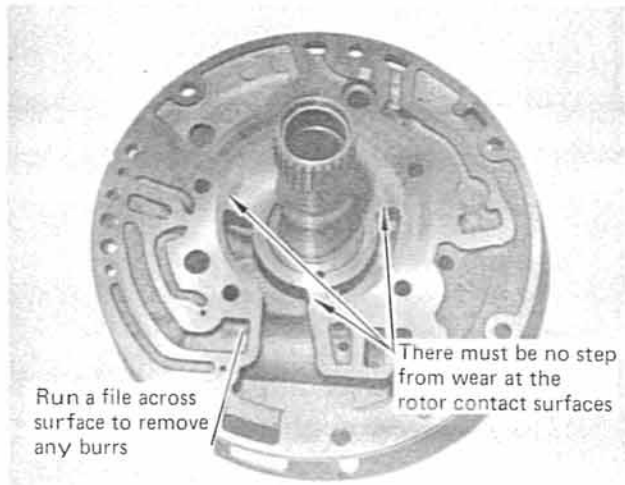

FIGURE 34

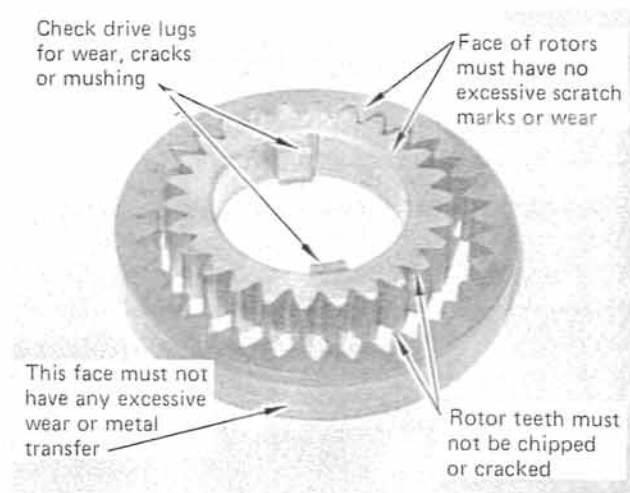

FIGURE 35

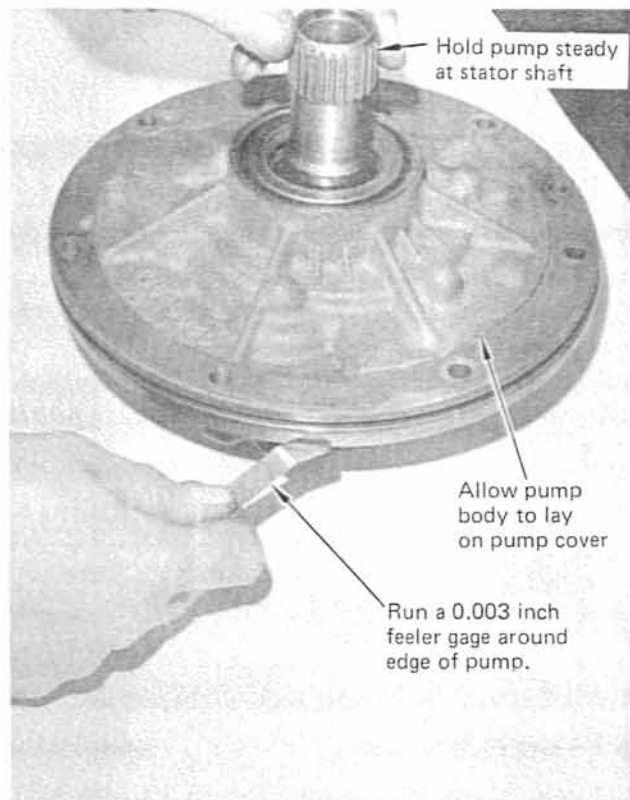

FIGURE 36

**Stator Shaft Bushings:** Replace as necessary.

**Pressure Regulator Valve:** Deburr spool faces with a stone. Do not round corners of the valve.

**STEP 4.** Install pressure regulator valve. (See Fig. 19) Install two horseshoe shaped shims (extra shim supplied with kit if your transmission originally equipped with only one shim). Install spring retainer with tabs pointing towards regulator spring.

**Heavy Duty:** Install stock pressure regulator spring.

**Street and Track:** Install special pressure regulator spring supplied with kit.

**STEP 5.** Install booster valve into booster sleeve. The valve must slide freely in the bore of the sleeve. Use a stone to remove any burrs from the valve face. Do not round the corners of the valve or grind any flat spots into the face. When the valve slides freely into the sleeve, put a small amount of grease

on the valve to hold it in place and install the valve into the sleeve.

**STEP 6.** Install the booster valve/sleeve assembly into the pump with the valve facing in. (See Fig. 37) Hold the sleeve in place and install the snap ring. Make sure the snap ring is fully seated in its groove. Install regulator valve plug in opposite end next to regulator valve. Push in on plug and install retaining pin into its hole.

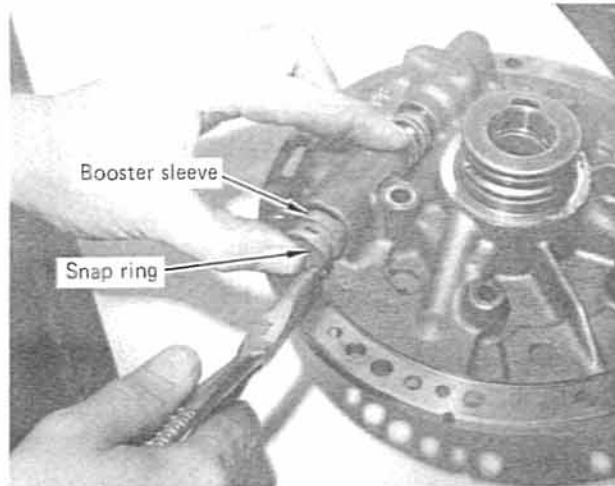

FIGURE 37

**STEP 7.** Install new front pump seal in the body. Check the fit of the rotors in the pump body. The rotors should slip in easily into the body with a close fit and rotate freely. Any interference from burrs or nicks can be removed with a stone.

**STEP 8.** Lubricate the pump body and rotors with transmission fluid and install the rotors into the pump body. The tangs or drive lugs on the inner rotor must be offset to the rear of the pump (away from the pump seal). **Installing the rotors backwards will damage pump, transmission and converter.**

**STEP 9.** Position the pump cover over the pump body. Align the outer bolt holes and hold the pump halves together while installing the five pump bolts finger tight. The outer edges of the pump must be aligned properly. This can be done by setting the pump into the transmission case, face down, and aligning the outer bolt holes with a screwdriver. (See Fig. 38) Do not install an O-ring on the outside diameter of the pump during this operation. Tighten pump bolts 18 to 20-ft lbs. Remove the pump from the case and set carefully over the neck of the torque converter. Rotate the entire pump assembly on the converter. It should rotate freely with a slight even resistance. Any bind or tightness indicates dirt, burrs or warpage interfering with the rotors. The pump will have to be disassembled and the problem corrected. **An incorrectly assembled pump will fail immediately!**

**STEP 10.** On variable pitch models, install pump gasket in position on the back of the pump. Align all holes properly and install stator control solenoid. (See Fig. 16) Tighten two

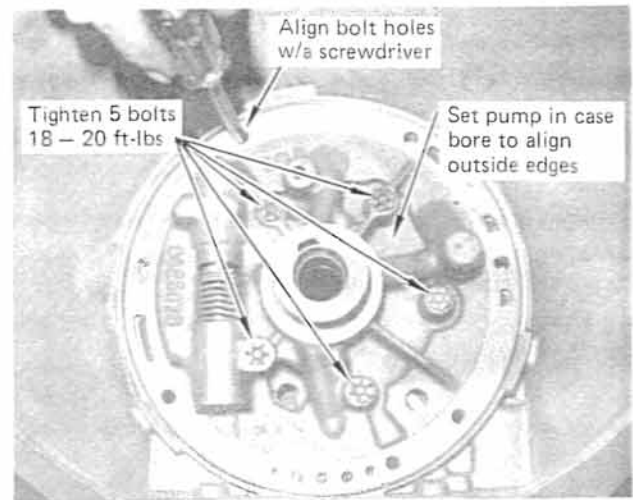

FIGURE 38

screws 20 to 25-in. lbs. Set pump aside where it won't get dirty.

### III. Forward Clutch (Refer to Figure 20)

**STEP 1.** Inspect the seal ring bore on the front of the clutch housing for wear or grooves. Excessive grooving will require housing replacement as the wear could fail the seal rings prematurely. Make sure the oil holes in the input shaft are clean and free from debris. On variable pitch models, replace the seal ring at the base of the input shaft with the correct one from the overhaul kit.

**STEP 2.** The forward and direct clutch pistons look similar and use the same size lip seals. The direct clutch piston has a steel check ball and the forward clutch piston has no check ball. Special note: The intermediate piston outer lip seal is only slightly smaller than the direct and forward outer lip seals. Lay all the lip seals out now and separate them; forward inner, middle and outer, direct inner, middle and outer (same as forward) and intermediate inner and outer.

**STEP 3.** Select the forward clutch piston and lip seals according to Step 2. Install the inner and outer seals in position on the piston.

**Heavy Duty and Street:** Install the middle seal in position on the forward clutch housing with the edge of the lip facing out.

**Track:** Do not install the middle seal.

Lubricate the seals lightly with automatic transmission fluid. Install the piston into the clutch housing using a 0.010 feeler gage to guide the seals into place. Be careful not to nick or cut the seal or fold the edge. If the piston is properly installed, it will turn in the bore with the piston all the way down.

**STEP 4.** Install sixteen return springs in their pockets. Install return spring retainer. Refer to the snap ring chart and select the retainer snap ring. Compress the retainer and springs

using a press or C-clamps. Be careful not to bend or distort the retainer. Install snap ring making sure it is seated in its groove. Release the retainer so it stops against the snap ring.

**STEP 5.** Inspect steel clutch plates. Note that one is wavy and the other four are flat. Soak five of the supplied friction plates in automatic transmission fluid for 15 minutes. Install the single wavy steel plate against the piston. Install alternately five of the thin (.077) steel plates and four friction discs ending with a friction disc.

**OPTIONAL:** Drill forward clutch hub as shown in Drawing #1. This modification increases the amount of oil to the forward clutches for improved lubrication and longer life.

**STEP 6.** Lubricate the forward clutch housing to clutch hub washer (bronze) with automatic transmission fluid or grease and position it on the front face of the clutch hub. (Note: This washer is similar to the forward clutch hub to direct clutch thrust washer which goes on the backside of the clutch hub and is usually made of plastic. The forward clutch housing to clutch hub washer is larger in diameter.) Install the clutch hub into the forward clutch housing, rotating as necessary to engage the friction discs.

**OPTIONAL:** Drill direct clutch driving hub as shown in Drawing #2. This modification increases the oil flow to the direct clutches for improved lubrication and longer life.

**STEP 7.** Install the direct clutch driving hub. Install snap ring in its groove making sure it is fully seated. Insert the mainshaft into the clutch hub and turn it. The hub should turn freely in both directions. If the hub does not turn freely check for proper hub installation, warped steel plates or friction discs or the use of the thicker direct clutch steels. Set the forward clutch assembly aside.

**IV. Direct Clutch (Refer to Figure 22)**

**STEP 1.** Inspect the seal ring bore on the rear of the clutch housing for wear or grooves. Excessive grooving will require housing replacement as the wear could fail the seal rings prematurely. Inspect the intermediate sprag race on the back of the housing. If the race is worn, pitted, or has chatter marks the housing will have to be replaced.

**STEP 2.** Select the direct clutch piston and lip seals according to Section C, Part III, Step 2. Install the inner and outer seals in position on the piston.

REVISIONS					
SYM	DESCRIPTION	DATE	DFTSMN	CHK	APPR

3. DEBURR HOLES & CLEAN HUB IN SOLVENT.  
 2. ADD ADDITIONAL 3/16" HOLES STAGGERED AS SHOWN FOR A TOTAL OF 12 HOLES.  
 1. OPEN EXISTING HOLES TO 3/16".

NOTES: UNLESS OTHERWISE SPECIFIED.

UNLESS OTHERWISE SPECIFIED	
1. DO NOT SCALE DRAWING 2. DIMENSIONS ARE IN INCHES 3. BREAK ALL SHARP CORNERS 3/16" MAX. 4. DIAMETERS TO BE CONCENTRIC WITHIN .005 T.I.R.	TOLERANCES XX - ±.010 XXX - ±.005 X - ±.004 ANGULAR ± 1/2° FINISH 125/
MATERIAL	DATE 12/11/68
FINISH	CHECKED BY
HEAT TREAT	APPROVED BY

<b>B&amp;M</b> AUTOMOTIVE PRODUCTS	
9152 INDEPENDENCE AVE CHATSWORTH, CA. 91311 (213) 882-6422	
DWG. TITLE <b>FORWARD CLUTCH HUB</b>	
DWG. NO. 1	REV.
SCALE NONE	SHEET 1 OF 1

DRAWING 1

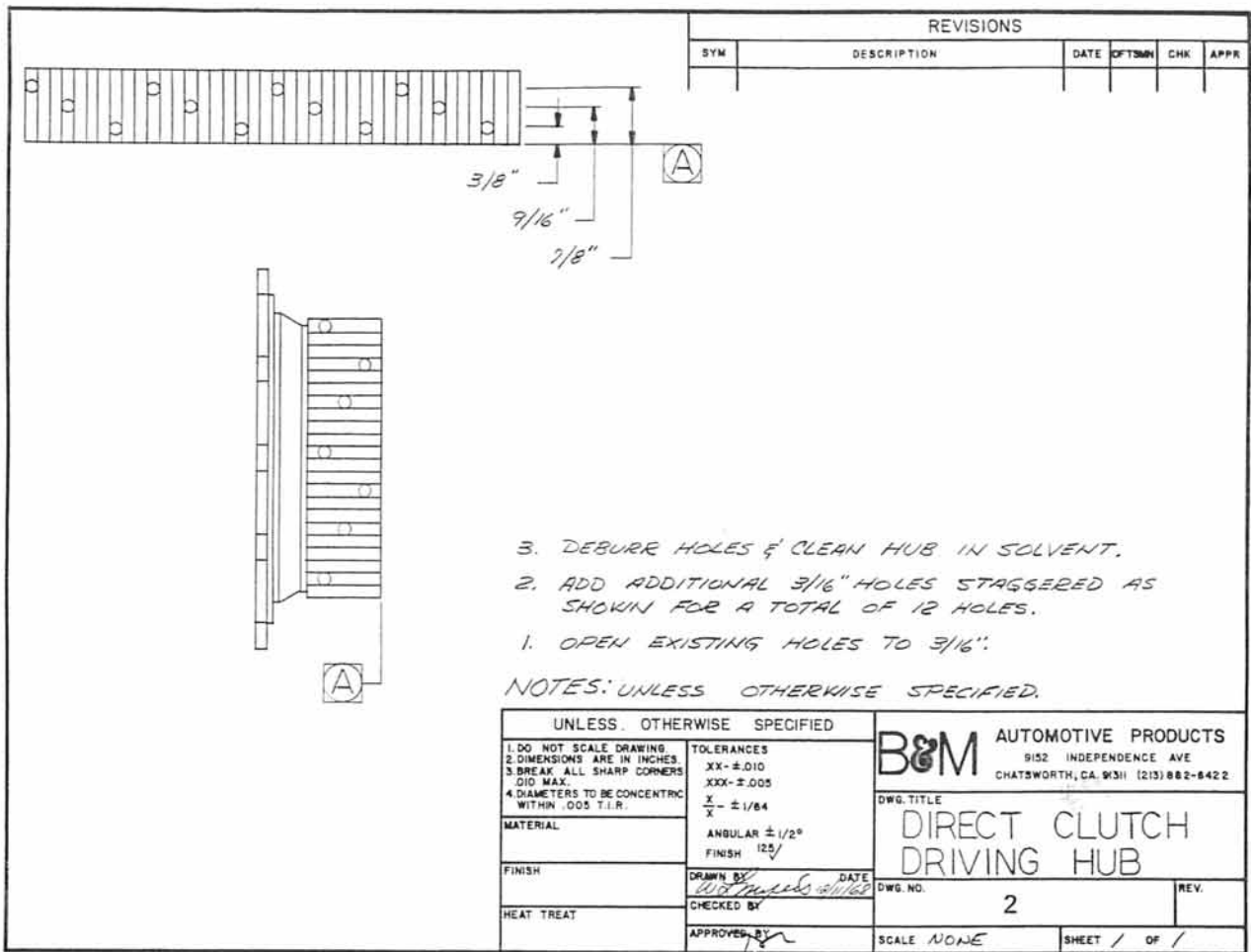

**DRAWING 2**

**Heavy Duty:** Install the middle seal in position on the direct clutch housing with the edge of the lip facing out.

**Street and Track:** Do not install the middle seal.

Lubricate the seals lightly with automatic transmission fluid. Install the piston into the clutch housing using a 0.010 feeler gage to guide the seals in place. Be careful not to nick or cut the seal or fold the edge. If the piston is properly installed, it will turn in the bore with the piston all the way down.

**STEP 3.** Install sixteen return springs in their pockets. Install return spring retainer. Refer to the snap ring chart and select the retainer snap ring. Compress the retainer and springs using a press or C-clamps. Be careful not to bend or distort the retainer. Install the snap ring. Do not expand the snap ring any more than necessary. Make sure the snap ring is completely seated in the groove. Release the press or C-clamps.

**STEP 4.** Soak five B&M direct clutch plates supplied with the kit in automatic transmission fluid for 15 minutes. Install alternately five thick (.090) steel plates supplied and five B&M friction discs starting with a steel plate and ending with a friction disc. Install the direct clutch backing plate and snap ring. Note: Six clutch housings will require the purchase of an extra plate from B&M to complete the assembly.

**STEP 5.** Use feeler gages to measure the clearance between the last friction disc and the backing plate. The clearance must be between 0.060 - 0.080 inch. The clearance can be adjusted by different thickness steel plates (GM Part No. 8623849, 0.077 thick; No. 8625197, 0.0915 thick). Do not use any wavy steel plates in the direct clutch pack.

**STEP 6.** Turn the direct clutch housing over and install the intermediate overrunning clutch. Note: 1971 and later models introduced the 8-element roller type overrunning clutch. This clutch is not recommended for performance applications. Use Direct Clutch Housing #8623061 or #8627433 and Sprag #8623116 with original outer race. For racing applications we suggest you install B&M Special Intermediate Sprag #20279 which will double second gear capacity. This is a sprag clutch and cannot be directly substituted for a roller clutch without changing the direct clutch housing.

**Roller Clutch:** Install eight rollers in the bushing cage. Install roller/cage assembly onto direct clutch housing. Install outer race, rotating the race clockwise while pushing down.

**Sprag Clutch:** Install one end bushing with the lip facing up. Install sprag inside outer race. Install race/sprag onto

drum rotating the race clockwise while pushing down. If the race will not rotate clockwise the sprag is upside down. Install end bushing with the lip facing down.

The sprag outer race must rotate freely clockwise while holding the direct clutch housing. Install the sprag retainer and snap ring. Make sure the snap ring is fully seated in its groove. Set the direct clutch assembly aside.

#### IV. Planetary Geartrain Assembly (Refer to Figure 25)

**STEP 1.** Inspect the following parts. Replace any excessively worn or damaged parts:

**Center Support:** Worn bushing, worn bushing diameter at rear, worn or damaged sprag inner race at rear, damaged seal ring grooves.

**Sun Shaft:** Worn or damaged bushings and bushing surfaces.

**Sun Gear:** Worn or pitted gear teeth.

**Main Shaft and Rear Internal Gear:** Worn or pitted gear teeth, worn bushing surfaces.

**Reaction Carrier:** Worn or pitted pinion gears, worn pinion thrust washers or excessive pinion end play, scarred, worn or burned band surface, worn bushing.

**Output Carrier:** Worn or pitted pinion gears, worn pinion thrust washers or excessive pinion end play.

**Output Shaft:** Worn bushing, or bushing surfaces, damaged splines.

Inspect all parts for wear or damage. Inspect reaction carrier bushing for damage (if the bushing is damaged, the carrier will have to be replaced). Check pinions for damage, rough bearings or excessive tilt. Pinion end play should be 0.009 - 0.024." Be sure oil lubrication holes are open on all shafts.

**STEP 2.** Separate and inspect the needle bearing assemblies. Check for pitting, wear or cracked races. Check for worn needles. Refer to Fig. 39 and match up bearings and races.

**STEP 3.** Drill out the orifice in the restrictor plug at the rear of the main shaft with the 1/8" drill supplied with the kit. Some mainshafts do not have a restrictor plug so no drilling is required. Clean out any metal chips. Hold the mainshaft/rear internal gear so the shaft points up. Install O.D. flange race (Bearing Assembly #2) against front face of rear internal gear with flange facing up. Install large needle bearing into race. Install I.D. flange race against needle bearing with flange facing down. Retain bearing assembly with grease.

**STEP 4.** Install mainshaft/rear internal gear assembly into the output carrier engaging the pinion gears. Hold the output carrier so the mainshaft points down. Install I.D. flange race (Bearing Assembly #3) against rear face of rear internal gear

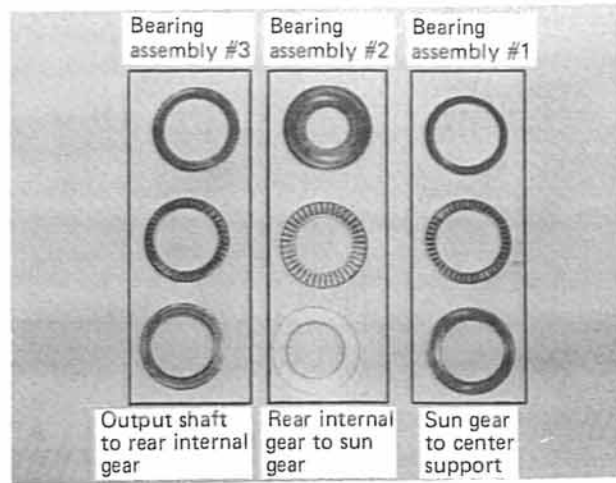

FIGURE 39

with flange facing up. Install needle bearing onto race. Install O.D. flange race against needle bearing with flange facing down. Retain bearing assembly with grease.

**STEP 5.** Install output shaft into output carrier engaging splines and pushing down until it bottoms out. Some rocking action may be necessary. Install output shaft snap ring into groove. If your transmission has a beveled snap ring, **it must be installed with the bevel out**. After the snap ring is installed in its groove, seat it by tapping each end of the snap ring firmly with a hammer and screwdriver. (See Fig. 40) If your output shaft has an O-ring seal, replace it with the O-ring in the kit.

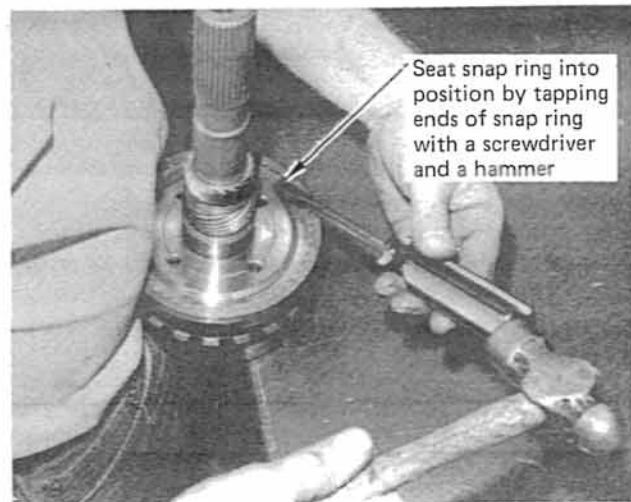

FIGURE 40

**STEP 6.** Turn the shaft assembly over so the output shaft points down. Install the sun gear so the **square edge** of the internal spline points **up** and the **chamfered edge** points **down**. Lubricate the mainshaft bushing diameters and install the sun gear shaft so the long spline engages the sun gear. Push the sun gear shaft down until it bottoms against the sun gear. (See Fig. 26)



**STEP 7.** Install four prong thrust washer in position on the front face of the output carrier. This washer is similar to the washer that goes on the back of the output shaft. Some models have two metal thrust washers, and some models have one metal and one plastic washer. Since you **must** use a metal washer at the back of the output shaft, the plastic washer is to be used at the carrier.

**STEP 8.** Install the plastic bushing in position on the outside of the output carrier. Lubricate the output carrier thrust washer and install the reaction carrier in position rotating to engage the pinions in the sun gear. The carrier should rotate freely. If not, check for a bind in the plastic bushing.

**STEP 9.** Low-reaction overrunning clutch:

**Roller Clutch:** Assemble sixteen rollers into the cage. Make sure the accordian type springs are not distorted. The springs should hold the rollers in position easily. The springs can be "stretched" slightly if necessary.

**Sprag Clutch:** This 36-element sprag is assembled. Inspect for excessive flat spots on the inside edge of the elements.

Install the low-reaction overrunning clutch into the low-reaction carrier.

**STEP 10.** Install I.D. flange race (Bearing Assembly #1) over the sun gear shaft against the sun gear with the flange facing up. This is the larger race of the two and is a close fit on the shaft. Lubricate the needle bearing and install in place against the race. Install the remaining I.D. flange race with the flange facing up.

**OPTIONAL:** Machine center support according to Drawing #3. This modification prevents case wear which allows center support to become mis-aligned.

**STEP 11.** Install inner and outer lip seals in position on the intermediate clutch piston. Lubricate the seals lightly with automatic transmission fluid. Install the piston into the center support using a 0.010 feeler gage to guide the seals in place. Be careful not to nick or cut the seal or fold the edge. Rotate the piston during installation to allow the spring pockets to clear the casting and seat fully. If the piston is properly installed, it will turn in the bore slightly.

**STEP 12.** Install piston return springs. B&M recommends using six return springs, one in each end pocket, however, three springs are sufficient. More than six springs are unnecessary. Position the spring retainer and install the snap ring.

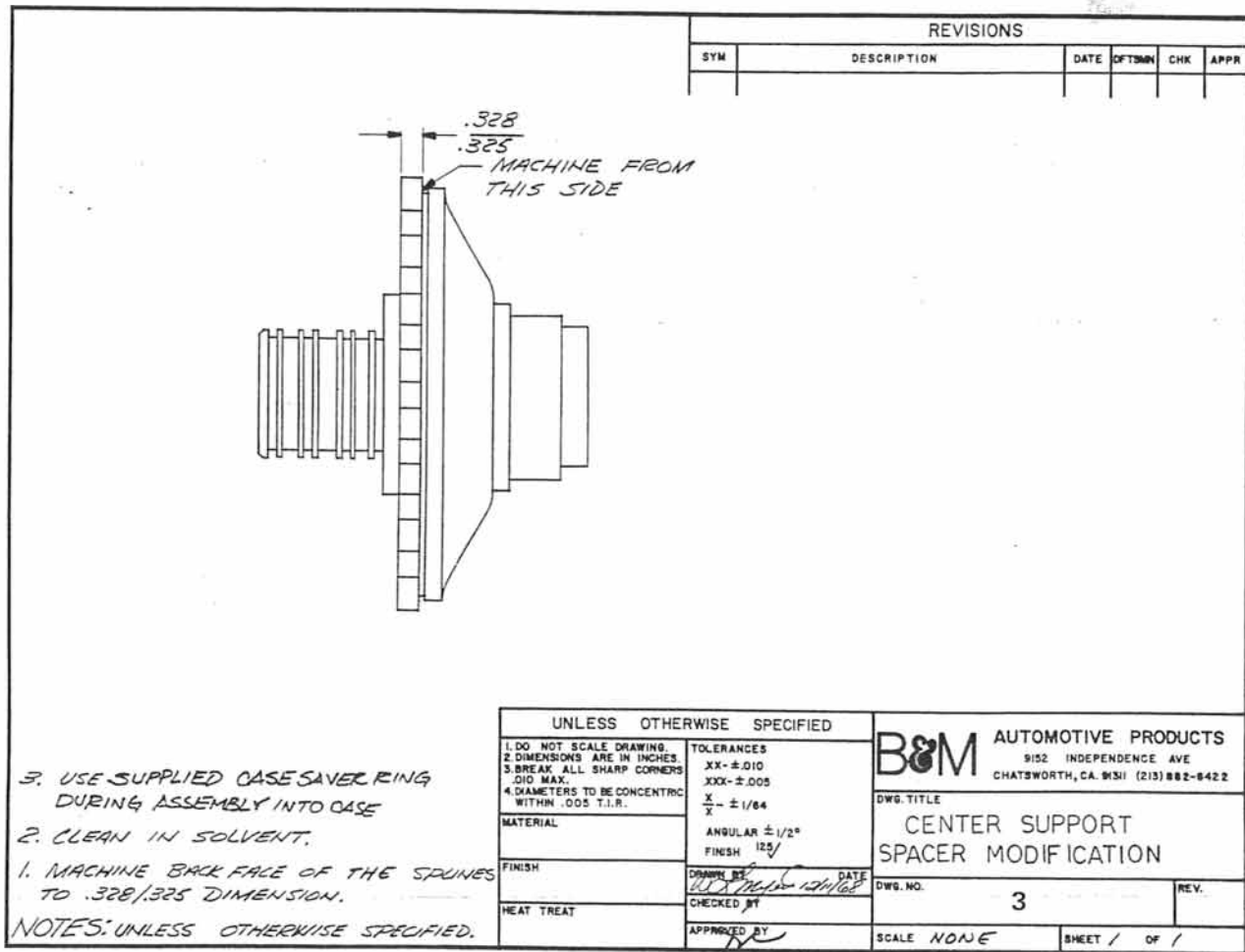

DRAWING 3

**STEP 13.** Turn the center support over and install the large diameter thrust washer in position inside the recess of the center support. (See Fig. 41) Hold the washer in place with grease. Lubricate the sun gear shaft. Install the center support on the geartrain assembly. Rotate and push down on the center support to engage the low-reaction overrunning clutch. When the center support is fully seated the low reaction carrier will have approximately 1/8" of end play. With the reaction carrier held, the center support must rotate counter-clockwise only looking down on the center support. Clockwise rotation indicates the overrunning clutch is in backwards.

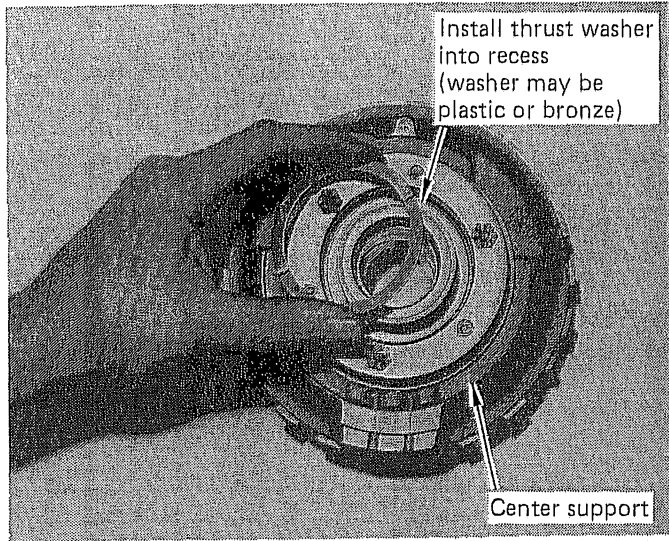

**FIGURE 41**

**STEP 14.** Install sealing rings in position. (See Fig. 42)

**Heavy Duty:** Four metal seal rings in grooves 1, 2, 3 and 4.

**Street and Track:** Three metal seal rings in grooves 1, 3 and 4. Do not install a ring in the #2 groove.

Spread each ring only as necessary to install it. Hook the ends of the ring together. The rings must spin freely in their grooves. If the rings do not spin freely, use a small file to de-

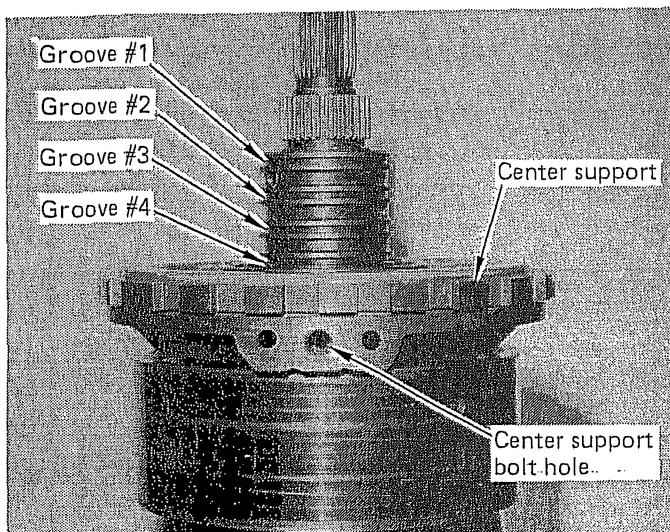
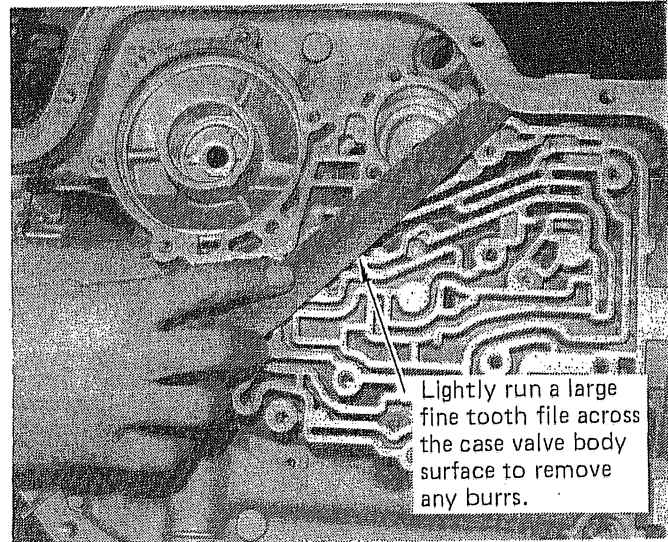

**FIGURE 42**

burr the groove. Set the planetary geartrain assembly aside.

## V. Case Preparation and Assembly

Run a large flat file across the valve body face of the case to remove any burrs or high spots. Be careful not to create any deep scratches in the surface. (See Fig. 43)



**FIGURE 43**

**STEP 1.** Install new manual shaft seal. (See Fig. 2)

**Lip Seal in Case:** Remove old seal by prying it out carefully with a screwdriver. Drive the new seal from the kit in place using a 1/2" socket or suitable tool as a driver.

**O-rings on Manual Shaft:** Install new O-rings from kit in position on shaft.

Lubricate seal or O-rings with automatic transmission fluid.

**STEP 2.** Partially install manual shaft into case. Install inside detent lever onto manual shaft with manual valve pin facing in. Install detent lever nut into place. Slide manual shaft into place and tighten nut securely. Install manual valve retaining pin so it engages manual shaft and holds it in place. Bend pin slightly so it won't come out.

**STEP 3.** Install park pawl return spring. (See Fig. 7) The square end goes around the park pawl and the round end hooks the case. Install park rod in position. Install retaining E-clip, if equipped. Install park rod guide as shown in Fig. 7. There are two park rod guides available. The cast iron guide can only install one way. The stamped steel guide must be installed according to Fig. 7. Install two bolts and tighten to 18-ft. lbs. The manual linkage should work smoothly and actuate the park pawl. Position the linkage so the pawl is retracted.

**Heavy Duty:** Go to Step 4.

**Street and Track:** Locate oil port "A." (See Fig. 7) Install special cup plug supplied with the kit into oil port "A." Drive the plug down until it is below the surface of the case. Make sure plug does not protrude into the inside of the case, where it will interfere with the center support.

**STEP 4.** Install the modulator valve into the case. (See Fig. 44) The valve should move freely with no bind. If any sticking is encountered deburr the valve with a stone and work the valve in and out carefully until it frees up. Remove the valve and blow out the bore to remove dirt. Install the modulator valve.

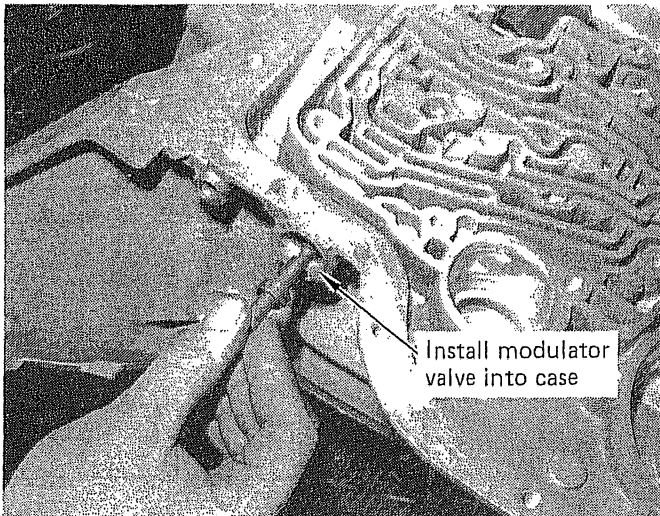

**FIGURE 44**

**STEP 5.**

**Heavy Duty and Street:** Install new vacuum modulator O-ring in position on modulator and install modulator into case. The last 1/8" of travel will be spring loaded.

**Track:** Install new vacuum modulator O-ring in position on special modulator plug supplied with the kit. Install plug into case.

Install modulator retaining clamp and bolt. Tighten bolt to 10-ft. lbs. Install plastic connector assembly into case with a new O-ring. This O-ring is the same size as the modulator O-ring. Coat O-ring with automatic transmission fluid before installation. Line up tab with notch in case and snap connector into case.

**STEP 6.** Install supplied rear brake band into case. (See Fig. 14) make sure band engages the two anchor pins in the case. Stick a thin screwdriver through the rear servo hole in the case and work the band to center it. If your transmission had a center support spacer snap ring, install supplied ring against the step one inch in front of the band.

**STEP 7.** Install the selective thrust washer in place at the back of the case. (See Fig. 14) Make sure the three tabs on the

washer engage the six pins. Use grease to hold the washer in place.

**STEP 8.** Install a metal four tab thrust washer in place on the back of the output shaft. Use grease to hold it in place. (See Fig. 27) The entire geartrain assembly must be installed in the case as a unit picking it up by the end of the mainshaft. Wrap the mainshaft spline with a layer of cardboard and hold the shaft with a pair of vise-grips.

**STEP 9.** Support the case so it is off the ground to provide clearance for the output shaft. When you install the geartrain, make sure you align the center support bolt hole with the hole in the case. (See Fig. 42) Install the geartrain assembly. Do this in one smooth operation, tapping down on the outer edge of the center support, with the assembly in the case, to seat the geartrain. Check for proper alignment of the center support bolt hole. (See Fig. 7)

**STEP 10.** Install the center support snap ring. The beveled edge must face up. Stake the snap ring with a hammer and a screwdriver to seat it fully. (See Fig. 45)

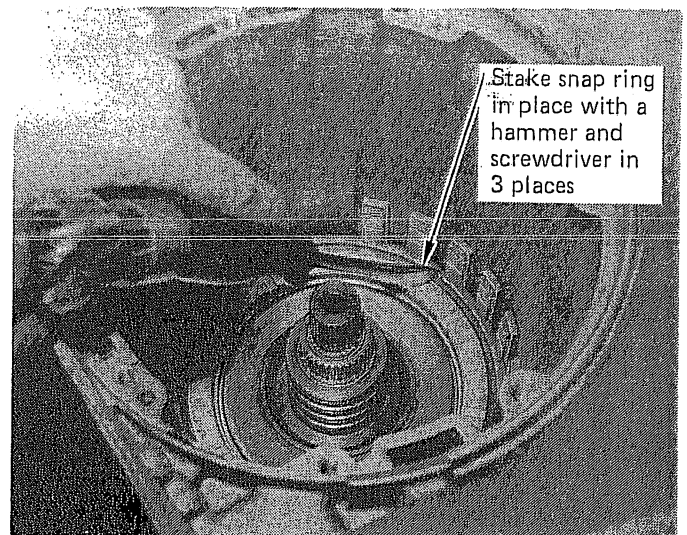

**FIGURE 45**

**STEP 11.** Insert a screwdriver into the rear portion of the case and load the output shaft forward. Insert a feeler gage between the four tab thrust washer and the three prong selective thrust plate. (See Fig. 46) End play should be 0.007 - 0.019". Adjustment can be made by different thickness thrust plates available from your GM dealer.

**STEP 12.** When end play is properly adjusted, install center support bolt. Insert a 1/4" diameter screwdriver blade into the oil hole next to the center support. (See Fig. 47) Firmly load the screwdriver to the side and tighten the center support bolt to 20 to 25-ft lbs. Remove the screwdriver. Make sure you have not raised any burrs during this step.

**STEP 13.** Soak the three B&M intermediate clutch plates supplied with the kit in automatic transmission fluid for 15 minutes. Install alternately three steel plates supplied and

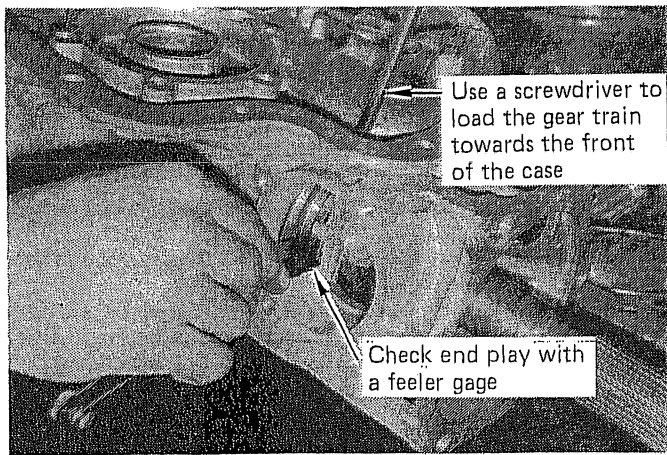

FIGURE 46

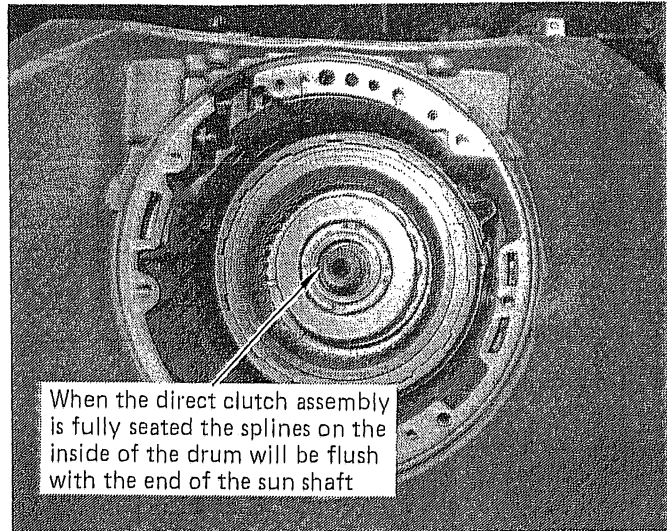

FIGURE 48

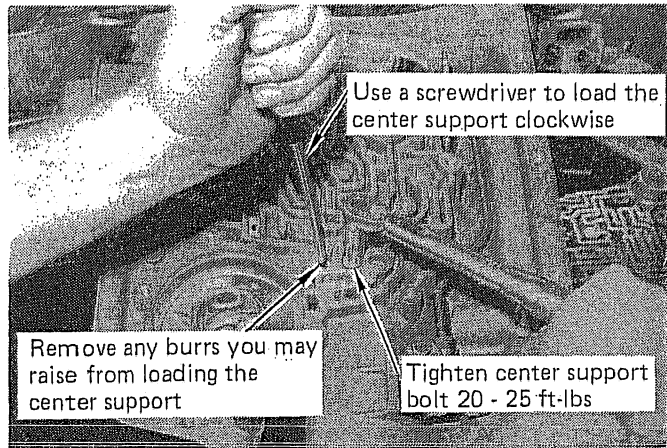

FIGURE 47

three B&M friction discs starting with a steel plate and ending with a friction disc. Install the intermediate clutch backing plate, flat side down, and snap ring. There is no clearance adjustment to make on the intermediate clutches. Stand the transmission on its output shaft.

**STEP 14.** Install supplied intermediate kickdown band into the case and engage the band in the anchor pin in the case. Align the three intermediate clutches and coat the metal seal rings on the center support with automatic transmission fluid.

**STEP 15.** Install the direct clutch assembly into the case. Hold the drum straight as you install it and rotate slightly to engage the clutches. It may be necessary to hold the intermediate kickdown band in position with a screwdriver to keep it from shifting out of alignment. When the direct clutch housing is fully seated and engaged, the splines of the drum will be flush with the front edge of the sun gear shaft. (See Fig. 48)

**STEP 16.** Coat the forward clutch hub to direct clutch thrust washer with grease and install it in position on the back of the forward clutch assembly. Install the forward clutch assembly into the case, rotating it to engage the direct clutches. You can count all five clutches as it engages each one.

**STEP 17.** Install the selective thrust washer in place on the

back of the pump. Use a small amount of grease to hold it in place. Lay gasket in position on the front face of the case. Note: Variable pitch models already have gasket on back of pump. Align pump and install in position. Install one pump bolt finger tight.

**STEP 18.** Check end play of input shaft. This can be done using a dial indicator on the end of the input shaft or by using feeler gages between the pump and forward clutch housing. (See Fig. 49) The output shaft must be loaded forward so keep the transmission on its output shaft. End play should be 0.003 - 0.024". End play can be adjusted using selective washers available from your GM dealer on the back of the pump.

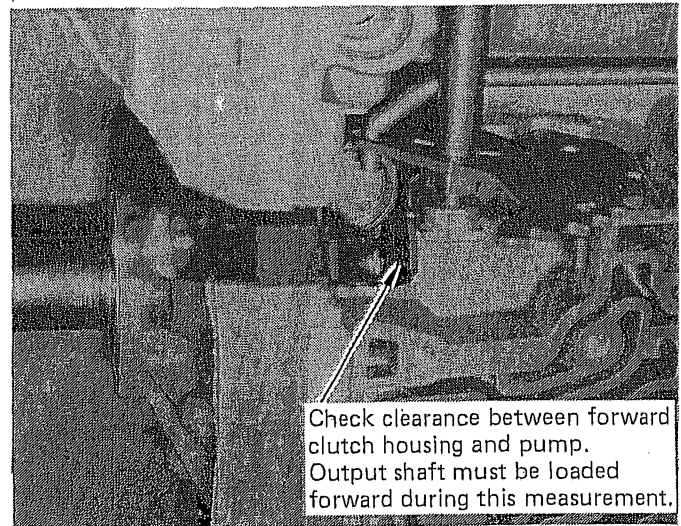

FIGURE 49

**STEP 19.** When end play is properly adjusted, remove pump from transmission. Install new O-ring in groove on outside diameter of pump housing. Make sure selective washer is in place on the back of the pump and install two hook-type seal rings in place. Note: These rings are the same size as the center support rings. Spread each ring only as necessary to in-

stall it. Hook the ends of the ring together. The rings must spin freely in their grooves. If the rings do not spin freely, use a small file to deburr the grooves.

**STEP 20.** Install two guide pins in opposite pump bolt holes. Guide pins can be made from two 5/16-18 X 2-1/2" bolts with the heads cut off. Pump gasket should still be in position. Lubricate the pump O-ring and the metal seal rings with automatic transmission fluid. Install the pump into the transmission. Variable pitch models: Guide the solenoid wire into the case past the manual valve linkage. Align pump with guide pins and seat the pump against the case.

**STEP 21.** Install two pump bolts in opposite holes. Draw each bolt down two turns at a time until the pump seats. Make sure the input shaft rotates freely. If it does not, a thrust washer is out of place or you did not fully engage a clutch. Remove the pump and check for the problem. Remove the two bolts and the guide pins. Install sealing washer or O-ring onto each pump bolt as required. Install six or eight pump bolts and tighten 18 to 20-ft. lbs.

**STEP 22.** Set the transmission on the bench valve body surface up. Install new metal seal rings on the 1-2 accumulator piston if it originally had metal rings. (See Fig. 50) Do not remove teflon seals. Install new seal onto rear servo piston. Lubricate accumulator piston and install into rear servo piston. Install accumulator spring into piston.

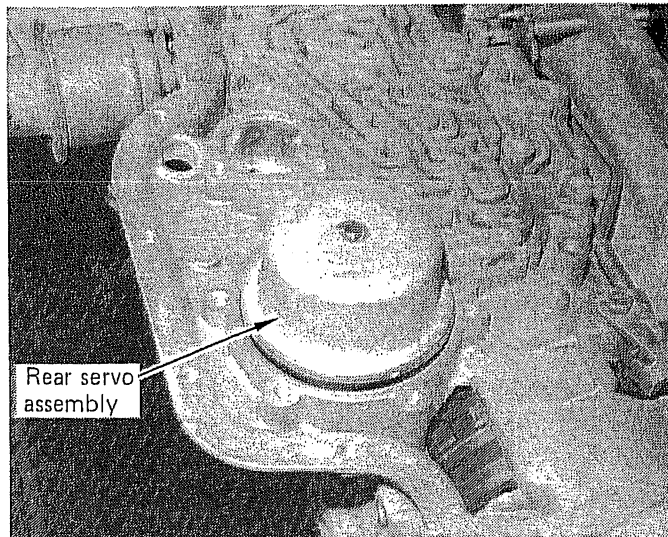

FIGURE 51

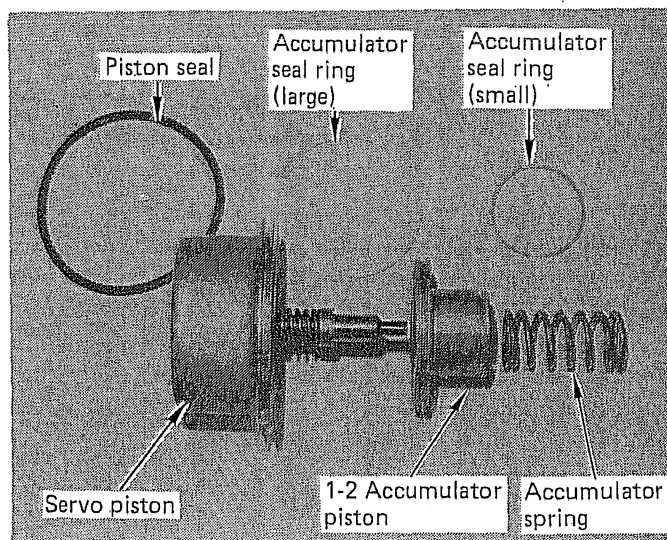

FIGURE 50

**STEP 23.** Lubricate piston seal with automatic transmission fluid. Install rear servo assembly into transmission case. (See Fig. 51) Install aluminum servo cover gasket in place. Install servo cover and six bolts and draw the bolts down slowly to seat the cover. Tighten bolts to 18 to 20-ft. lbs.

**STEP 24.** Install new metal seal ring on the intermediate servo piston if it originally had a metal ring. (See Fig. 52) Do not remove teflon seals. (See Fig. 53) Lubricate seal with automatic transmission fluid and install servo assembly into case. (See Fig. 7)

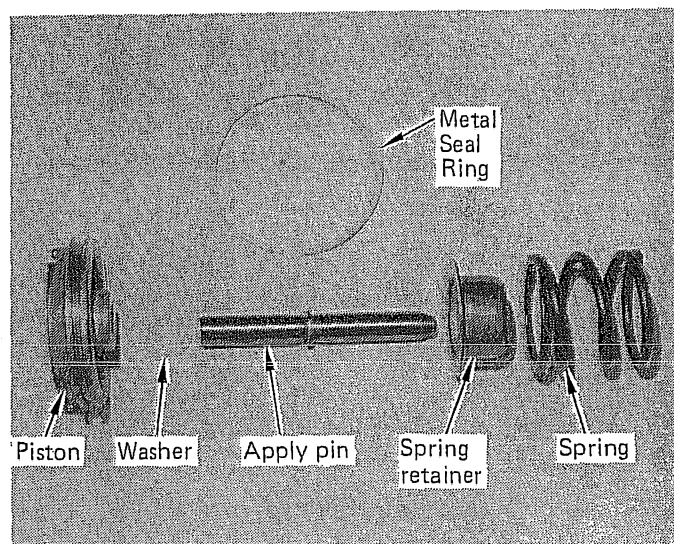

FIGURE 52

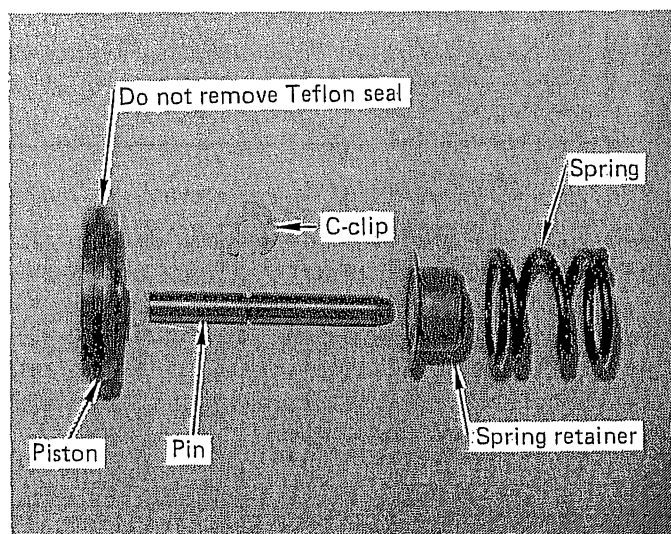

FIGURE 53

For full manual control with standard shift pattern, install Manualpak #20219.

**STEP 25.** Install 1/4" steel check balls in locations shown in Fig. 7.

- Heavy Duty: Six balls in locations, 1 thru 6.
- Street: Five balls in locations 1, 2, 3, 4, and 6.
- Track: Two balls in locations 3 and 6.

**STEP 26.** Take a break.

**STEP 27.** Position upper valve body gasket (larger of the two valve body gaskets) against the case. Install the separator plate from the kit. Install lower valve body gasket into position. Install your two guide pins into two valve body holes to hold plate and gaskets in alignment. (See Fig. 54)

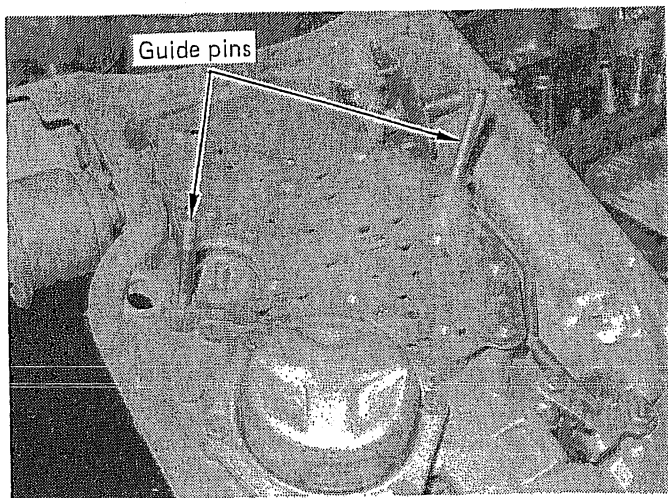

FIGURE 54

**STEP 28.** Carefully examine detent solenoid.

**Oval Can Solenoids:** Check to make sure orifice disc is properly seated in detent solenoid housing. (See Fig. 55) If this disc is missing, your transmission will be in passing gear all the time. Install detent solenoid in position using new aluminum gasket supplied in kit. Install 1/4-20 retaining bolts, **finger tight**.

**Square Can Solenoids:** Check to make sure the built-in rubber seal is in good condition and has no nicks or cuts. (See Fig. 56) If the seal is damaged, you will have to replace the solenoid. If the seal leaks, your transmission will be in passing gear all the time. Install detent solenoid in position. **Do not** use the aluminum gasket supplied with the kit. Install 1/4-20 retaining bolts **finger tight**.

**STEP 29.** Insert governor tubes into position in valve body. Make sure manual valve is in place. Install valve body onto transmission using guide pins to maintain alignment. Guide governor tubes into position and engage manual valve in linkage. Install one valve body bolt in place and draw it down care-

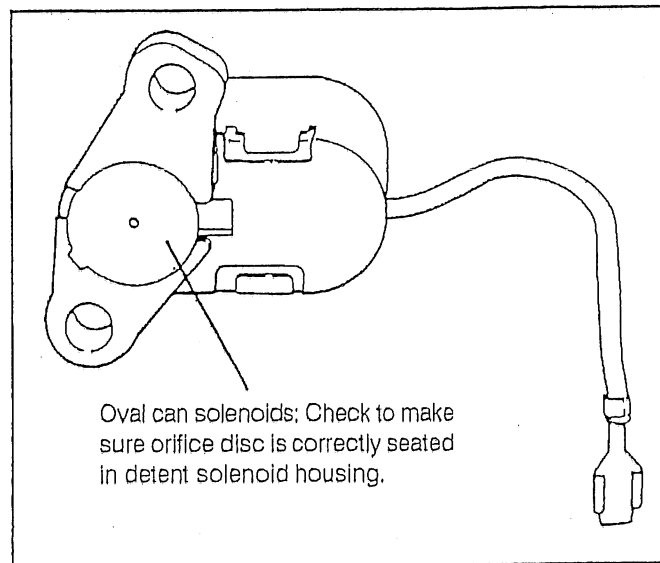

FIGURE 55

fully to seat valve body. Do not tighten. Tap governor tubes down lightly to seat them.

**STEP 30.** Remove guide pins and install all valve body bolts. Install detent roller spring so it engages inside detent lever. Tighten valve body bolts 8 to 10-ft. lbs. Tighten detent solenoid bolts 8 to 10-ft. lbs. Selector lever should shift freely with positive indexing in each gear. Connect detent solenoid wire to vertical terminal on connector.

**Variable Pitch:** Insert stator signal wire into plug first. Connect plug to connector.

**'71 and Later Smog:** Connect white smog wire to pressure switch on valve body and to horizontal terminal on connector.

**STEP 31.** Install new oil filter. For longer transmission life and improved oiling system, install B&M Competition Oil Pickup #20287. Install two filter tube O-rings on your pick-up tube. (See Fig. 57) Thoroughly lubricate the O-rings with automatic transmission fluid. Push the pick-up tube-filter assembly into the transmission. On '68 and later models install the filter retaining bolt and torque to 10-ft lbs. This bolt has a 1/2" shoulder on it so the filter is free to "float."

**STEP 32.** Inspect governor for damage. Replace as necessary. Lubricate governor bore with automatic transmission fluid and install governor assembly. (See Fig. 58) Install governor cover and gasket. Tighten four bolts 18 to 20-ft. lbs.

**STEP 33.** Install new O-ring on speedometer sleeve. Install new inner seal with clip. Install speedometer gear into sleeve. Lubricate O-ring with automatic transmission fluid. Use retainer to align sleeve and install speedometer sleeve into case. Install retainer and bolt. Tighten bolt securely.

**STEP 34.** Drill a 1/2" hole in the oil pan in the area shown in Fig. 59. Deburr hole. Install drainplug sleeve assembly with plastic gasket on the outside and tighten nut. (See Fig. 60) Hold outer sleeve with a wrench when removing and installing drainplug.

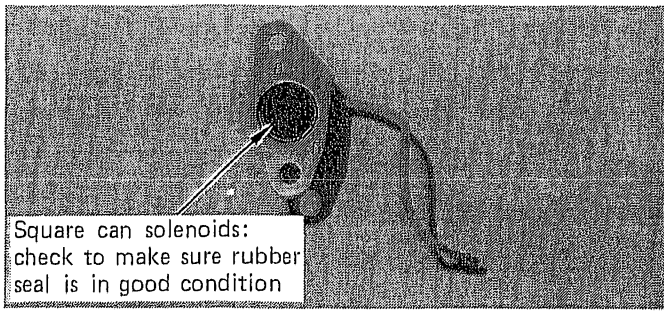

FIGURE 56

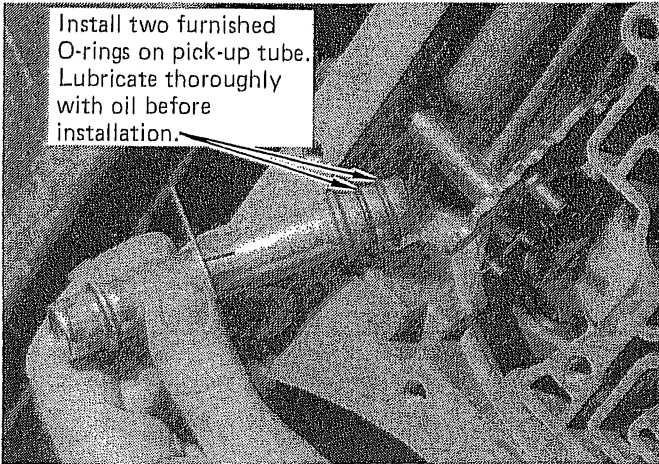

FIGURE 57

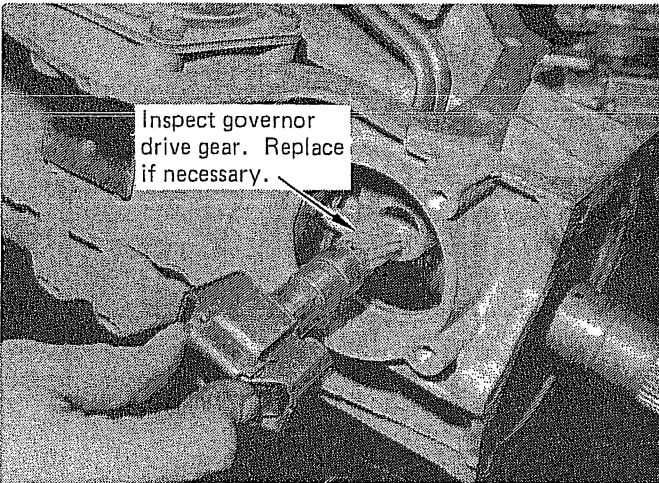

FIGURE 58

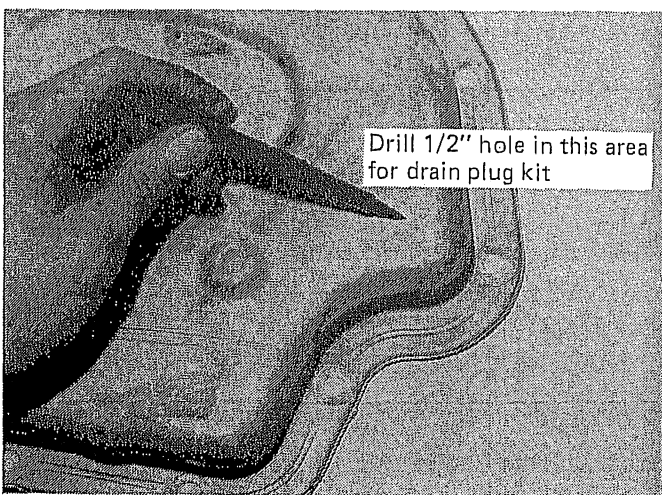

FIGURE 59

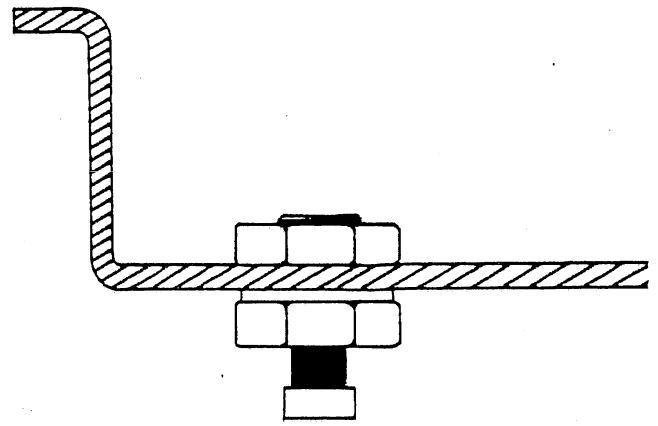

FIGURE 60

**STEP 35.** Install pan and new gasket. Tighten pan bolts 12 to 13-ft. lbs. Do not over tighten pan as this will cause leaks.

**STEP 36.** Install correct extension housing seal from kit into extension housing. Install housing onto transmission with new gasket. Tighten six bolts 23 to 25-ft. lbs.

**STEP 37.** Install 1/8" pipe plug into case on left side. Tighten securely. Install oil cooler fittings. Make sure metal gaskets are in place on fittings. Tighten 15 to 20-ft. lbs.

The transmission is now assembled. The final step is installation into the vehicle.

## TRANSMISSION INSTALLATION

**STEP 1.** Lubricate the pump bushing with automatic transmission fluid. Install the torque converter, pushing and rotating until the lug face is a minimum 1" inside the bellhousing. If converter is not correctly engaged in pump and transmission is pulled up to block with bolts it will break drive tangs off pump rotor and ruin the pump.

**STEP 2.** Install transmission/converter assembly against motor. Make sure the converter does not fall out of position. Transmission must fit flush against engine block with no effort. Install bellhousing bolts and tighten 35 to 40-ft. lbs. Converter must rotate freely at this point. Check for insufficient engagement or rust in crank pilot bore if it does not turn freely.

**STEP 3.** Install rear mount and crossmember in place. Tighten mount and crossmember bolts. Install dipstick tube. Connect oil cooler lines.

**Heavy Duty and Street:** Connect vacuum line to modulator.

**Track:** Remove vacuum line and plug at manifold.

**STEP 4.** Install three converter bolts. Tighten 30 to 35-ft. lbs. Install dust pan and bolts. Tighten to 8-ft. lbs. Connect kickdown wire to connector. Connect speedometer cable and tighten securely.

**STEP 5.** Install driveshaft and tighten U-bolts securely. Connect shift linkage. Check shifter. Adjust according to the manufacturer.

**STEP 6.** Lower vehicle and add 6 quarts of B&M Trick Shift or Type F fluid. While Trick Shift is superior in heat capacity, lubrication and friction material performance, we recommend Type F fluid over Dexron or Type A. Keep the rear wheels off the ground if possible. Start engine and place shifter in the Neutral position. Add fluid until the oil level is between the Add and Full marks. Shift the transmission through all the gear positions. If the rear wheels are off the ground, allow the transmission to shift through all gears several times. Place selector in Neutral and check fluid. Do not overfill. Check for leaks at cooler lines, etc.

**STEP 7.** Drive vehicle for 1-2 miles to warm up transmission. Check fluid level. It must be between the Add and Full marks. Do not overfill!! This will cause foaming and overheating.

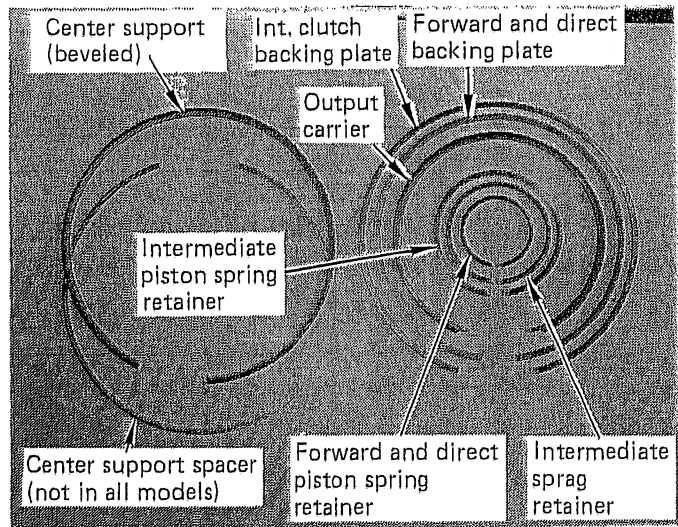

SNAP RING I.D. CHART

## TURBO HYDRO 400 TROUBLE SHOOTING GUIDE

Malfunction	Probable Cause	Malfunction	Probable Cause
#1 Slips	Valve body bolts loose	#3 Slips 2-3 Shift	Check #1 first
	Low fluid level		Direct Clutch piston seals damaged
	Pump bolts loose		Center support bolt loose or missing.
	Booster and regulator valve improperly installed	Cup plug missing from oil port "A"	
	Piston lip seals cut or improperly installed	Center support oil rings damaged or missing	
	Check balls improperly installed	#4 No Drive in "D" Range	Low fluid level
	Vacuum modulator valve sticking		Shifter misadjusted
#2 Slips 1-2 Shift	Oil seal rings broken on pump and/or center support	Manual valve disconnected from detent lever	
	Check #1 first	Forward clutch not operating properly	
	1-2 Accumulator piston rings damaged	#5 No 1-2 Upshift	Governor sticking
	1-2 Accumulator piston bore damaged		Governor drive gear worn or loose
Intermediate clutch piston seals damaged	Kickdown solenoid loose or damaged		
Center support bolt loose or missing	1-2 Shift valve stuck or assembled improperly		



Malfunction	Probable Cause	Malfunction	Probable Cause
	Cup plug installed too deep in valve body	<b>#9 No Reverse</b>	Check #8 first
	Intermediate clutch piston seals damaged		2-3 Shift valve stuck in 3rd gear position
	Center support bolt loose or missing		Direct clutch piston seals damaged or missing
	Governor tube not properly installed		Center support oil rings damaged or missing
<b>#6 No 2-3 Upshift</b>	Check #5 first	<b>#10 Late Hard Shifts</b>	Vacuum line cracked or leaking
	2-3 Shift valve stuck		Vacuum modulator diaphragm ruptured
	Valve body bolts loose		Kickdown solenoid loose or damaged
	Direct clutch piston seals damaged		Kickdown solenoid gasket damaged
	Center support oil rings damaged or missing		Modulator plug installed in Heavy Duty or Street unit
<b>#7 No 3-2 Downshift (No engine braking)</b>	Front servo or accumulator oil rings damaged	<b>#11 Pump Buzz or Whine</b>	Low fluid level (oil starvation)
	Servo bore in case damaged		High fluid level (foaming)
	Front band broken		Pick-up tube O-rings damaged or missing
	Front band not engaged in anchor pin in case		Filter defective or restricted
	Front band not engaged in servo pin	<b>#12 Overheating, Foaming Oil at Dipstick or Breather</b>	Insufficient cooler capacity
<b>#8 No 2-1 Downshift (No engine braking)</b>	Check ball #6 missing		High fluid level
	Rear servo seal damaged or missing		Restricted or plugged cooler lines
	Rear servo gasket damaged or leaking	<b>#13 No Upshift with Competition Modification</b>	Install vacuum modulator in place of plug (See Section C, Part V, Step 5) but do not connect vacuum modulator
	Rear band broken or not engaged in anchor pins		
	Cup plug in valve body missing		
	The above will also affect reverse		

TOOLS AND MATERIALS REQUIRED FOR

TURBO HYDRO 400 TRANSKIT

INSTALLATION

(1)	Speed Handle or Ratchet – 3/8" Drive	(1)	Arkansas Stone
(1)	9/16" Socket – 3/8" Drive	(1)	Small Hammer
(1)	1/2" Socket – 3/8" Drive	(1)	Torque Wrench, 0 to 50-ft. lbs.
(1)	7/16" Socket – 3/8" Drive	(1)	1/4" Drill Motor
(1)	3/8" Socket, 12 Point – 3/8" Drive	(1)	Vise
(1)	Small Blade Screwdriver	(2)	5" C-Clamps
(1)	Medium Blade Screwdriver	(1)	Feeler Gage
(1)	Large Blade Screwdriver	(1)	Dial Indicator (Optional)
(1)	Snap Ring Pliers, Needle Tip, Compression	(1)	1/4" Punch
(1)	Snap Ring Pliers, Flat Tip, Expansion		
(1)	Needle Nose Pliers	(12)	Quarts of Trick Shift or Type F ATF
(1)	Vise Grips		Vaseline or white grease
(1)	Medium Flat File, Fine Tooth		Cleaning solvent (1) gallon
			Carburetor cleaner or Gunk, if required

PARTS LIST

(1)	Overhaul Seal Kit	(1)	Modulator Plug
(1)	Separator Plate	(1)	Drain Plug Kit
(1)	O-Ring	(3)	Steel Int. Plate
(1)	Park Pawl Plug	(5)	Steel .077 Plate
(1)	Pressure Regulator Shim	(5)	Steel .090 Plate
(1)	Snap Ring	(3)	Friction Int. Plate
(1)	Pressure Regulator Spring	(10)	Friction Fwd/Dir. Plate
(1)	1-2 Shift Valve	(1)	Reverse Band
(1)	.385 Plug	(1)	Intermediate Kickdown Band
(1)	.190 Plug	(1)	Case Saver Ring

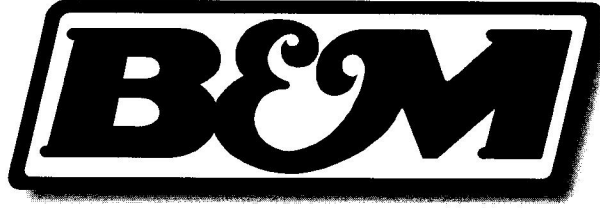

## Instruction Addendum **B&M TransKit**

©2000 by B&M Racing and Performance Products

The B&M TransKits now contain all the friction materials needed to completely rebuild the transmission. The TransKit instructions must be read through completely before you begin installation in order to become familiar with the terms and components you will be working with. The . instructions will mention to save certain friction material for reinstallation, however we now supply all new friction materials. Retain the old used friction materials for comparison only.

### TRANSKIT #10229

#### CONTAINS THE FOLLOWING FRICTION MATERIALS:

- FORWARD CLUTCHES (REAR CLUTCH) 4 EA.
- FORWARD STEELS 4 EA. RECOMMENDED CLEARANCE: .015-.035".
- DIRECT CLUTCHES (FRONT CLUTCH) 5 EA.
- DIRECT STEELS 4 EA. RECOMMENDED CLEARANCE: .060-.080".
- INTERMEDIATE BAND (KICKDOWN BAND) 1 EA.
- ADJUSTMENT: TIGHTEN BAND ADJUSTING SCREW TO 72 INCH LBS. AND BACK OFF 1 1/2 TURNS, THE SUPPLIED 5.0 SERVO LEVER MUST BE USED WITH THE SUPPLIED INTERMEDIATE BAND FOR OPTIMUM RESULTS.
- REAR BAND 1 EA.
- ADJUSTMENT: TIGHTEN INTERNAL ADJUSTING SCREW TO 72 INCH LBS. AND BACK OFF 3 TURNS.

### TRANSKIT #20229

#### CONTAINS THE FOLLOWING FRICTION MATERIALS:

- FORWARD CLUTCHES 5 EA.
- FORWARD STEELS (.077) 5 EA. RECOMMENDED CLEARANCE: .025-.045"
- DIRECT CLUTCHES 5 EA.
- DIRECT STEELS (.090) 5 EA. RECOMMENDED CLEARANCE: .060-.080"
- INTERMEDIATE CLUTCHES 3 EA.
- INTERMEDIATE STEELS 3 EA.
- REAR BAND 1 EA.
- INTERMEDIATE KICKDOWN BAND 1 EA.
- **NOTE**: #20229 CONTAINS THE VALVE BODY COMPONENTS FOR 1965-1987 ONLY. ~ NOT ATTEMPT TO INSTALL THESE COMPONENTS INTO A 1988 OR LATER TH400.

### TRANSKIT #30229

#### CONTAINS THE FOLLOWING FRICTION MATERIALS:

- FORWARD CLUTCHES 5 EA.
- FORWARD STEELS 5 EA. RECOMMENDED CLEARANCE: .015-.030".
- DIRECT CLUTCHES 5 EA.
- DIRECT STEELS 5 EA. RECOMMENDED CLEARANCE: .060-.080"
- NOTE: TO INSTALL 5 FRICTIONS INTO THE DIRECT DRUM A FORWARD CLUTCH PRESSURE PLATE MAY BE NEEDED (GM P/N 6261072).
- INTERMEDIATE CLUTCHES 3 EA.
- INTERMEDIATE STEELS 3 EA.
- LOW-REVERSE CLUTCHES 5 EA.
- LOW-REVERSE STEELS 5 EA.
- INTERMEDIATE OVERRUN BRAKE BAND 1 EA.

### TRANSKIT #40230

#### CONTAINS THE FOLLOWING FRICTION MATERIALS:

- REVERSE-HIGH CLUTCHES (DIRECT CLUTCHES) 5 EA.
- REVERSE-HIGH STEELS 5 EA. RECOMMENDED CLEARANCE: .060-80"
- FORWARD CLUTCHES 5 EA.
- FORWARD STEELS 4 EA. RECOMMENDED CLEARANCE: .020-.040".
- LOW-REVERSE CLUTCHES 5 EA.
- LOW-REVERSE STEELS 5 EA.
- INTERMEDIATE BAND 1 EA.
- ADJUSTMENT: TIGHTEN BAND ADJUSTING SCREW TO 120 INCH LBS. AND BACK OFF 1 1/2 TURNS.

### TRANSKIT #50231

#### CONTAINS THE FOLLOWING FRICTION MATERIALS:

- FORWARD CLUTCHES 5 EA.
- FORWARD STEELS 4 EA. RECOMMENDED CLEARANCE: .025-.040".
- REVERSE-HIGH CLUTCHES (DIRECT) 4 EA.
- REVERSE-HIGH STEELS 4 EA. RECOMMENDED CLEARANCE: .050-.066".
- LOW-REVERSE (REAR) BAND 1 EA.
- ADJUSTMENT: TIGHTEN BAND ADJUSTING SCREW TO 120 INCH LBS. AND BACK OFF 3 TURNS.
- INTERMEDIATE (FRONT) BAND 1 EA.
- ADJUSTMENT: TIGHTEN BAND ADJUSTING SCREW TO 120 INCH LBS. AND BACK OFF 1 3/4 TURNS.

### TRANSKIT #70230

#### CONTAINS THE FOLLOWING FRICTION MATERIALS:

- 3-4 CLUTCHES 6 EA.
- 3-4 STEELS .5 EA.
- FORWARD CLUTCHES 5 EA.
- FORWARD STEELS 4 EA.
- LOW & REVERSE CLUTCHES 5 EA.
- LOW & REVERSE STEELS 5 EA.
- REVERSE INPUT CLUTCHES 4 EA.
- REVERSE INPUT STEELS 3 EA.
- OVERRUN CLUTCHES 2 EA.
- OVERRUN STEELS 2 EA.
- 2-4 BAND 1 EA.

#9500510-02